

**SPESIFIKASI PERBENDAHARAAN
MALAYSIA SARAWAK BAGI
PERABOT JENIS KERUSI FABRIK,
MEJA BERANGKAI
BESI/LOGAM/KAYU**

ITEM NO 1: HIGH BACK

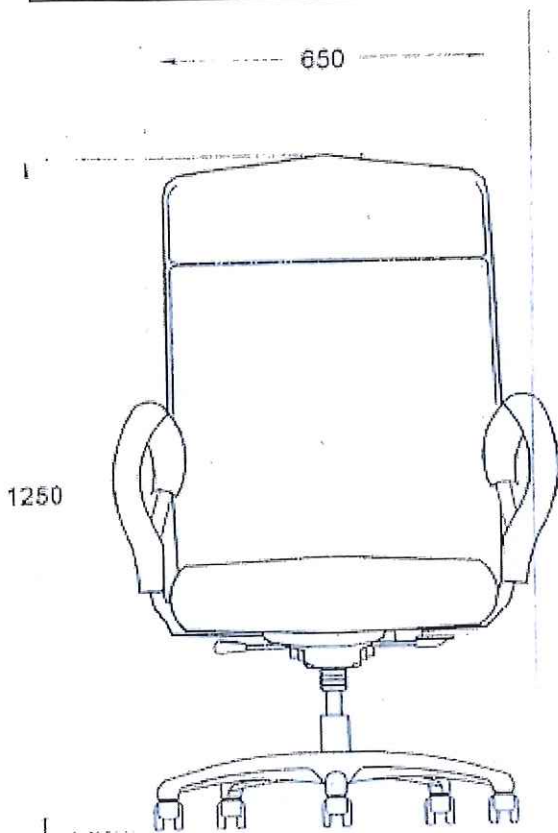

PANDANGAN HADAPAN

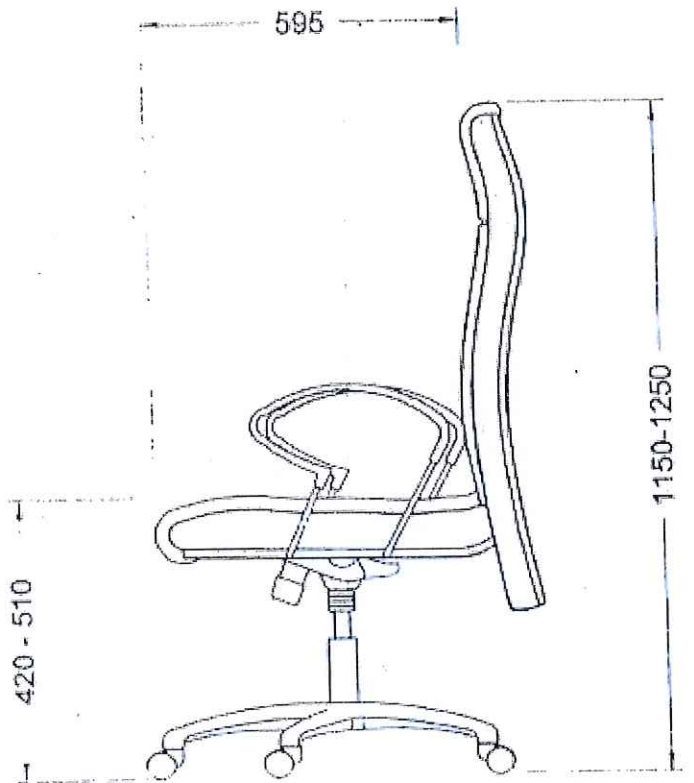

PANDANGAN SISI

ITEM	SPECIFICATION
Shell structure (for seat)	One piece self supporting long fibre veneer laminated wood with 12mm thickness and anatomically shaped to provide seating comfort
Seat	Density 38
Backrest	Density 30
Armrest	Polypropylene or equivalent (any design)
Frame	29mm diameter/epoxy/black
Base	350mm Bas (polished) black base
Castors	Twin wheel high resistance nylon castors – heavy duty.
Fabric	Polyester – min 42,000 cycle
Gaslift	Pneumatic height adjustable
Dust Cover	Spiral

ITEM NO 10: CANTILEVER CHAIR C/W ARM

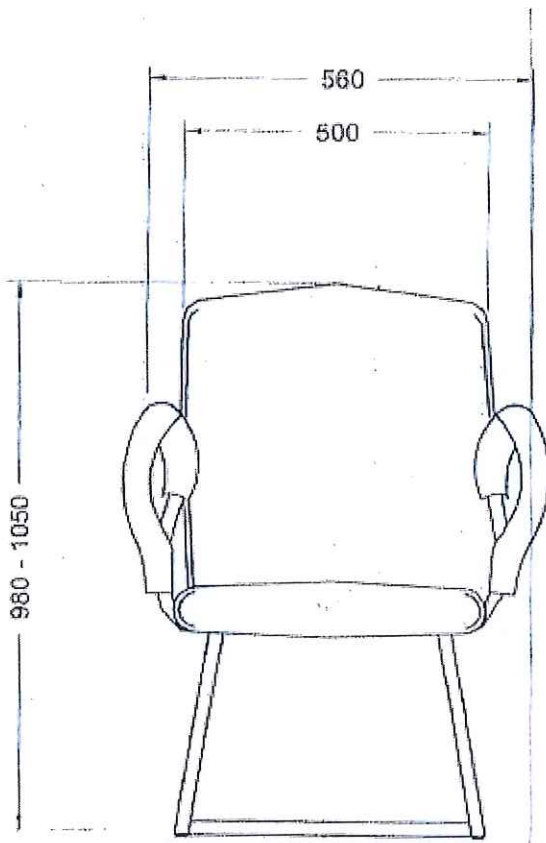

PANDANGAN HADAPAN

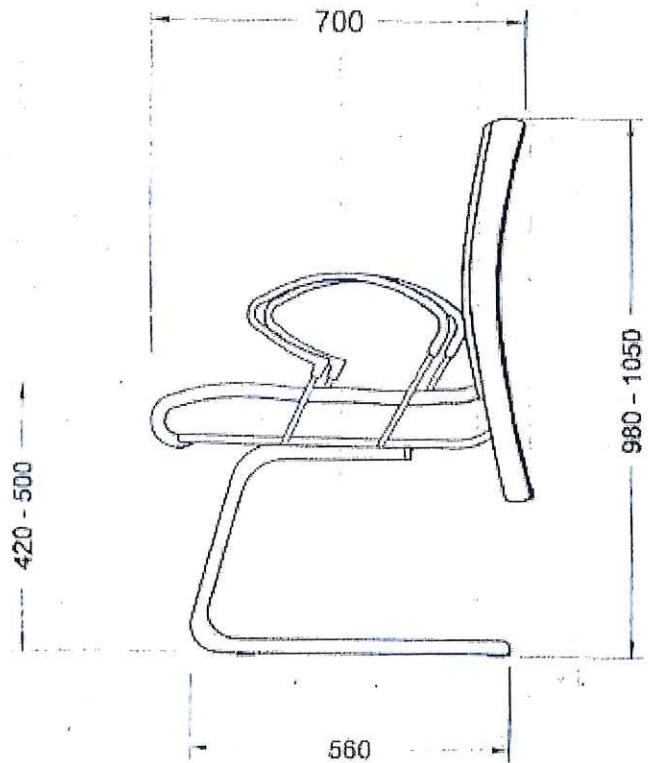

PANDANGAN SISI

ITEM	SPECIFICATION
Shell structure (for seat)	One piece self supporting long fibre veneer laminated wood with 12mm thickness and anatomically shaped to provide seating comfort
Seat	Density 38
Backrest	Density 30
Armrest	Polypropylene or equivalent (any design)
Frame	29mm diameter/epoxy/black
Base	Cantilever (black)
Fabric	Polyester – min 42,000 cycle

ITEM NO 2: MEDIUM BACK

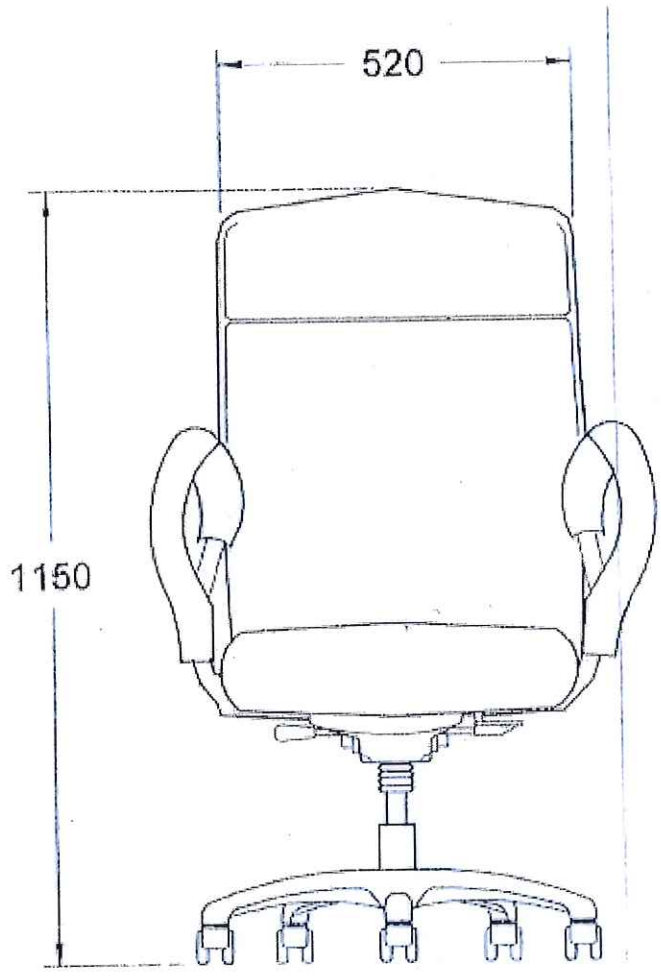

PANDANGAN HADAPAN

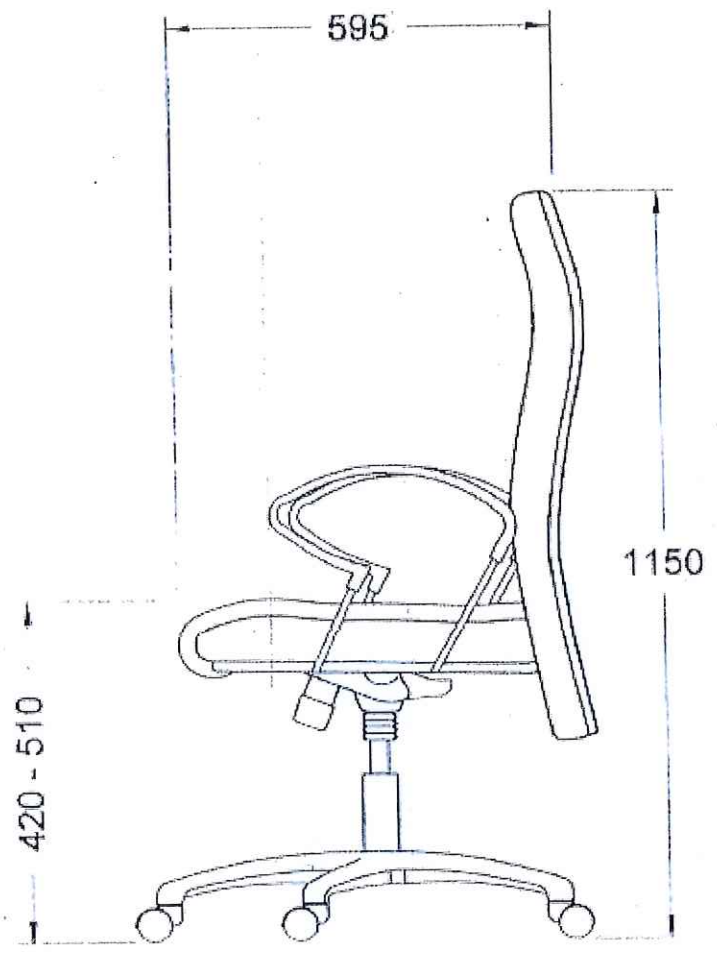

PANDANGAN SISI

ITEM	SPECIFICATION
Shell structure (for seat)	One piece self supporting long fibre veneer laminated wood with 12mm thickness and anatomically shaped to provide seating comfort
Seat	Density 38
Backrest	Density 30
Armrest	Polypropylene or equivalent (any design)
Frame	29mm diameter/epoxy/black
Base	350mm Bas (polished) black base
Castors	Twin wheel high resistance nylon castors – heavy duty.
Fabric	Polyester – min 42,000 cycle
Gaslift	Pneumatic height adjustable
Dust Cover	Spiral

ITEM NO 3: LOW BACK

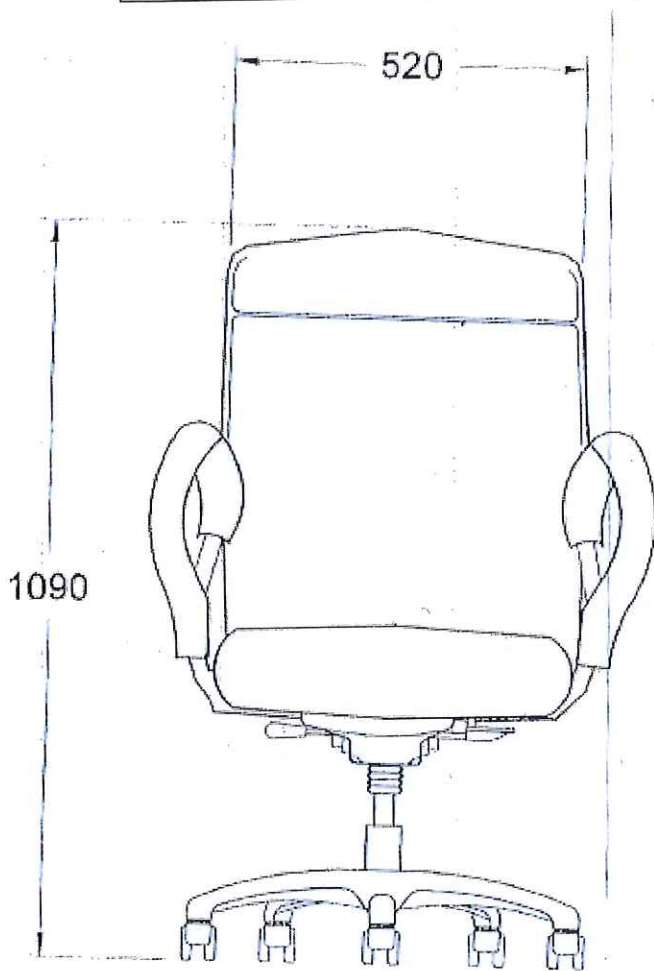

PANDANGAN HADAPAN

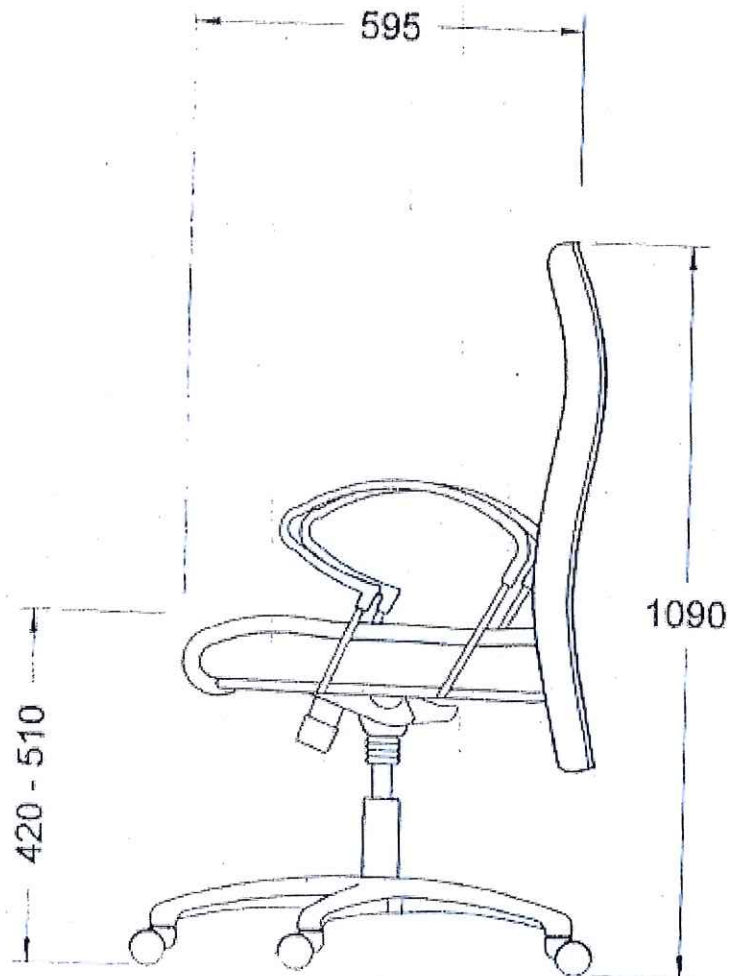

PANDANGAN SISI

ITEM	SPECIFICATION
Shell structure (for seat)	One piece self supporting long fibre veneer laminated wood with 12mm thickness and anatomically shaped to provide seating comfort
Seat	Density 38
Backrest	Density 30
Armrest	Polypropylene or equivalent (any design)
Frame	29mm diameter/epoxy/black
Base	350mm Bas (polished) black base
Castors	Twin wheel high resistance nylon castors – heavy duty.
Fabric	Polyester – min 42,000 cycle
Gaslift	Pneumatic height adjustable
Dust Cover	Spiral

DIMENSION

DIM.	HIZ. 4
A.	625mm-635mm
B.	765mm-775mm
C.	525mm-535mm
D.	425mm-435mm

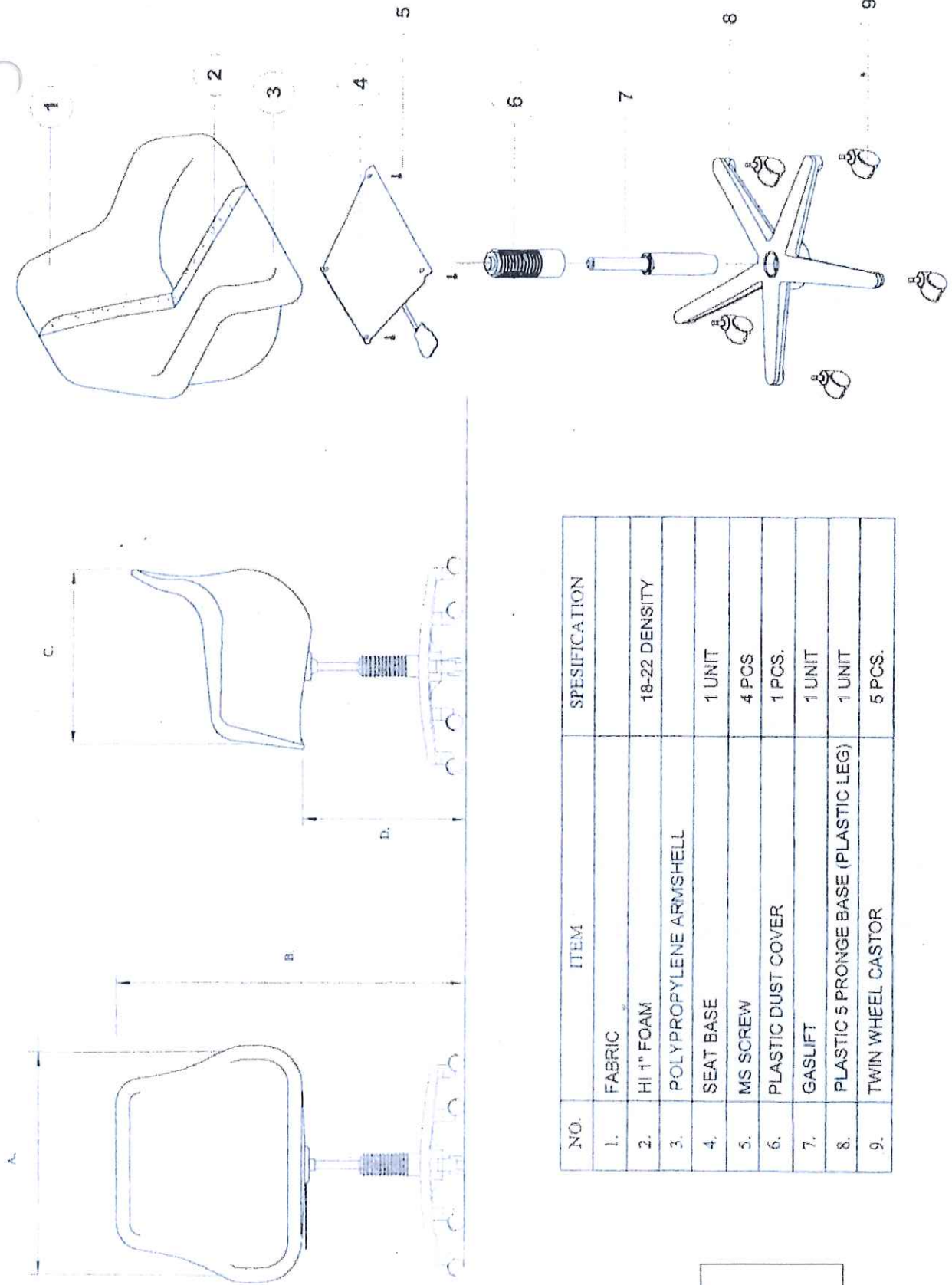

NO.	ITEM	SPESIFICATION
1.	FABRIC	
2.	HI 1" FOAM	18-22 DENSITY
3.	POLYPROPYLENE ARMSHELL	
4.	SEAT BASE	1 UNIT
5.	MS SCREW	4 PCS
6.	PLASTIC DUST COVER	1 PCS.
7.	GASLIFT	1 UNIT
8.	PLASTIC 5 PRONGE BASE (PLASTIC LEG)	1 UNIT
9.	TWIN WHEEL CASTOR	5 PCS.

Item 4 :
 Bucket Armshell
 Chair CW Fabric

DIMENSION

DIM.	HIZ. SA
A.	530mm-560mm
B.	880 MAX.
C.	500mm-520mm

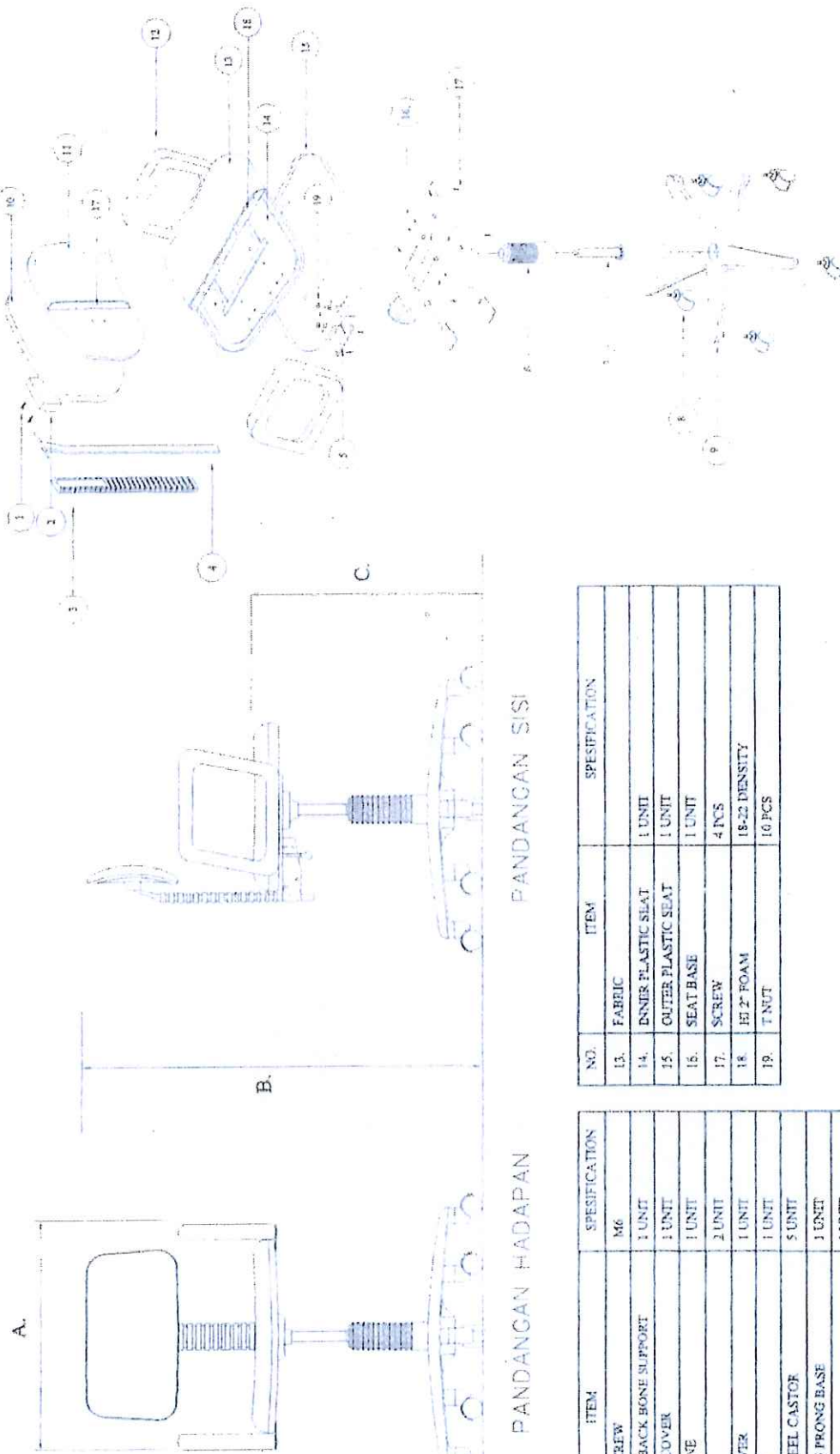

PANDANGAN HADAPAN

PANDANGAN SISI

NO.	ITEM	SPEKIFICATION
1.	ALLEN SCREW	M6
2.	CAP FOR BACK BONE SUPPORT	1 UNIT
3.	PLASTIC COVER	1 UNIT
4.	BACK BONE	1 UNIT
5.	BRACKET	2 UNIT
6.	DUST COVER	1 UNIT
7.	GAS LIFT	1 UNIT
8.	TWIN WHEEL CASTOR	5 UNIT
9.	PLASTIC 5 PRONG BASE	1 UNIT
10.	OUTER PLASTIC BACKRAST	1 UNIT
11.	INNER PLASTIC BACKREST	1 UNIT
12.	ARMREST	1 SET

NO.	ITEM	SPEKIFICATION
13.	FABRIC	
14.	INNER PLASTIC SEAT	1 UNIT
15.	OUTER PLASTIC SEAT	1 UNIT
16.	SEAT BASE	1 UNIT
17.	SCREW	4 PCS
18.	HI 2' FOAM	18-22 DENSITY
19.	T NUT	10 PCS

Item 5 :
Typist Chair
CW Arm

DIMENSION

DIML	HIZ. 1B.
A.	440mm-450mm
B.	880 MAX.
C.	500mm-520mm

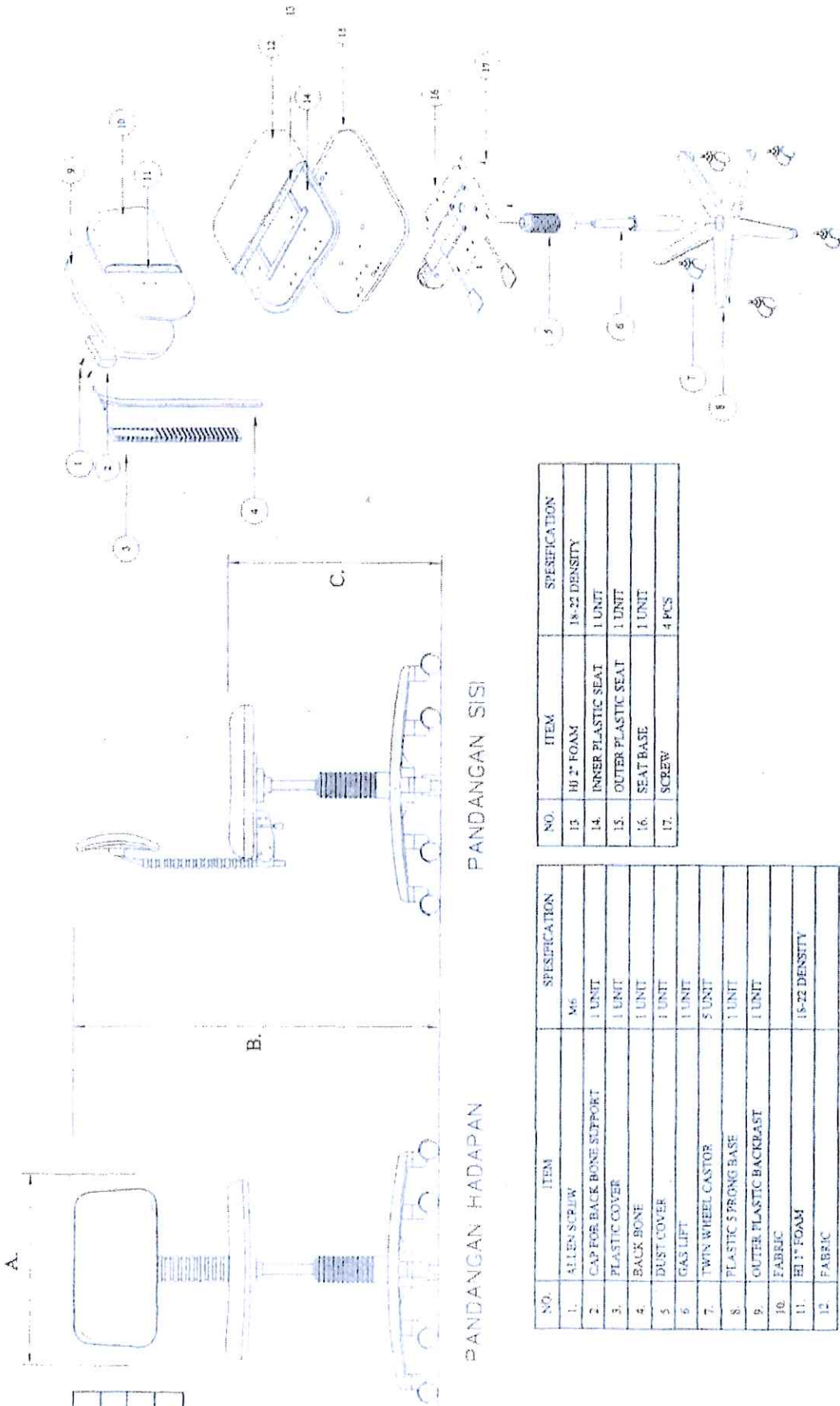

NO.	ITEM	SPECIFICATION
1.	ALLEN SCREW	M 6
2.	CAP FOR BACK BONE SUPPORT	1 UNIT
3.	PLASTIC COVER	1 UNIT
4.	BACK BONE	1 UNIT
5.	DUST COVER	1 UNIT
6.	GAS LIFT	1 UNIT
7.	TWIN WHEEL CASTOR	5 UNIT
8.	PLASTIC SPRING BASE	1 UNIT
9.	OUTER PLASTIC BACKREST	1 UNIT
10.	FABRIC	
11.	1 1/2" FOAM	15-22 DENSITY
12.	FABRIC	

NO.	ITEM	SPECIFICATION
13.	16 1/2" FOAM	18-22 DENSITY
14.	INNER PLASTIC SEAT	1 UNIT
15.	OUTER PLASTIC SEAT	1 UNIT
16.	SEAT BASE	1 UNIT
17.	SCREW	4 PCS

Item 6 :
Typist Chair
W/O Arm

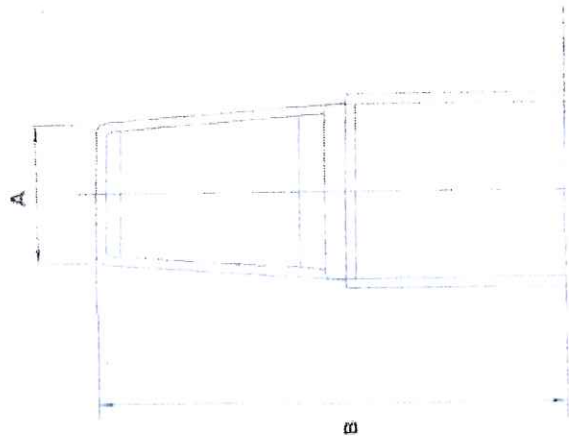

PANDANGAN HADAPAN

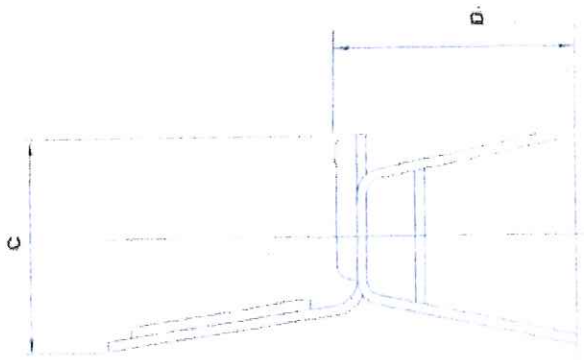

PANDANGAN SISI

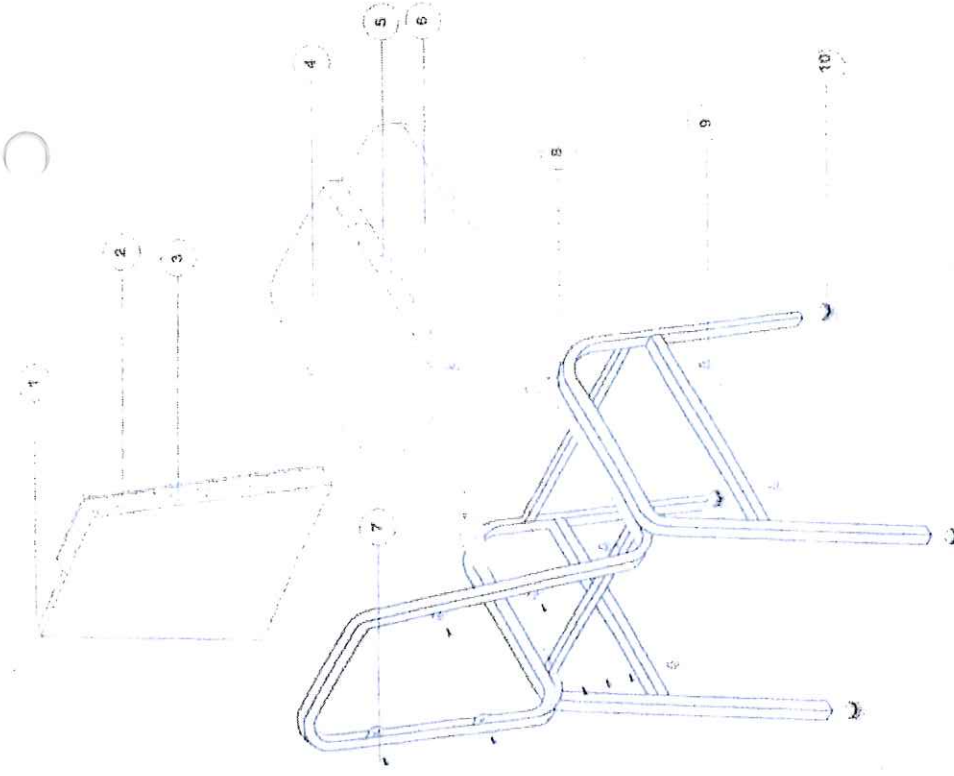

DIM	HIZ 7B
A	265mm-275mm
B	915mm-925mm
C	515mm-525mm
D	475mm-485mm

NO	ITEM	SPECIFICATION
1	PLYWOOD 9mm BACKREST	1 UNIT
2	FABRIC	
3	HI 1" FOAM	18-22 DENSITY
4	FABRIC	
5	HI 2" FOAM	18-22 DENSITY
6	PLYWOOD 9mm SEAT	1 UNIT
7	MS SCREW	
8	ALUMINIUM FRAME	1 UNIT
9	STACKING STUD	4 PCS.
10	PLASTIC STUD	4 PCS

Item 7 :
Aluminium Banquet Chair

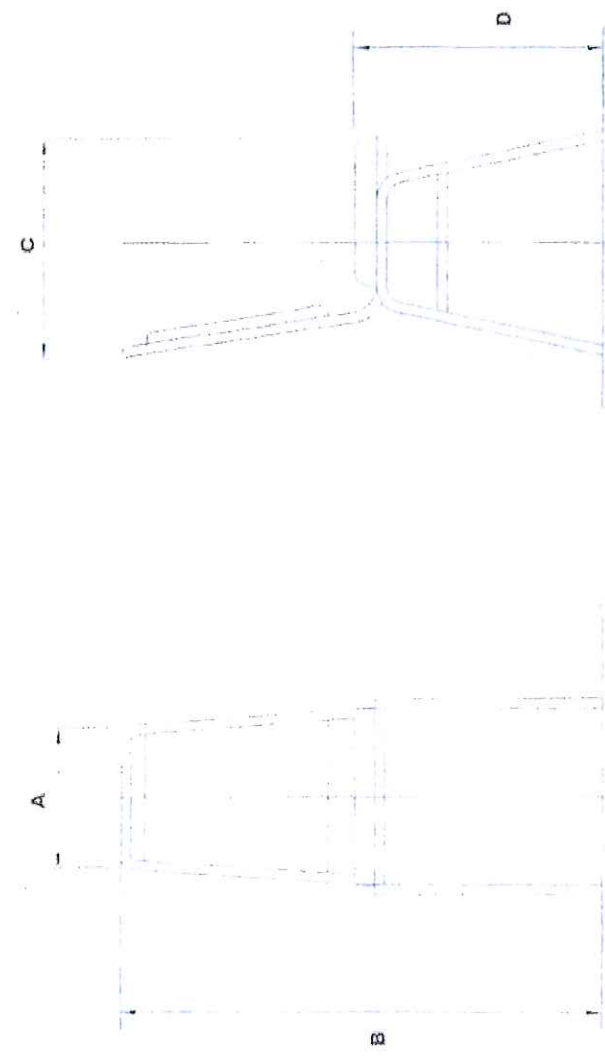

PANDANGAN HADAPAN

PANDANGAN SISI

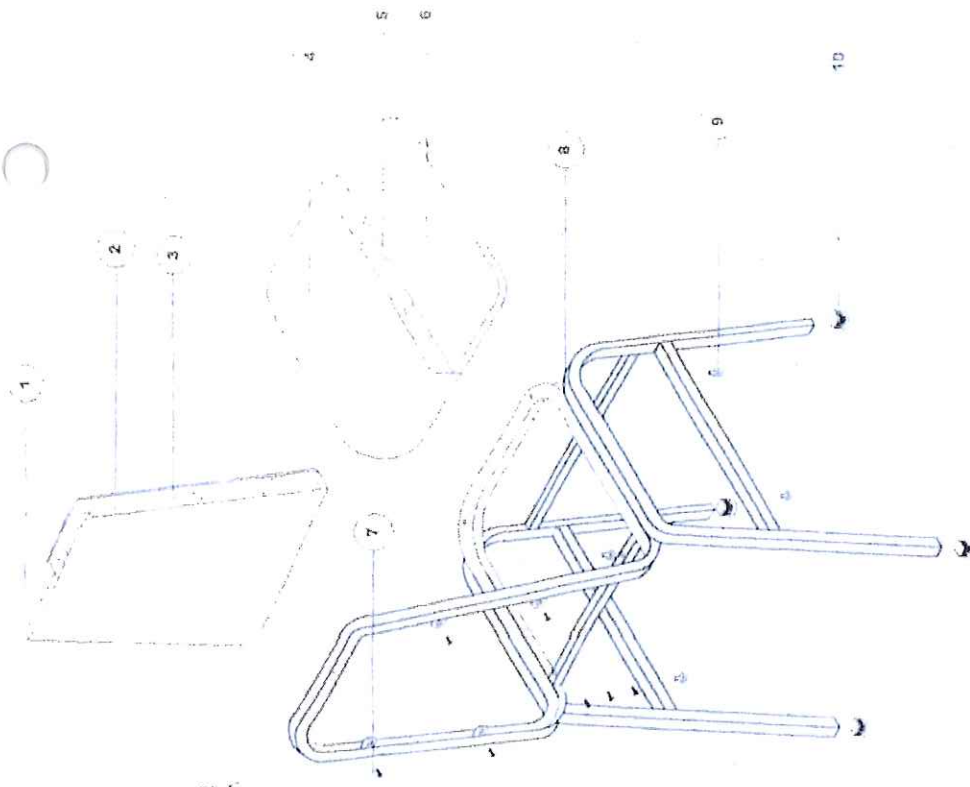

Item 8 :
Banquet Chair

DIM	HIZ 7B
A	265mm-275mm
B	915mm-925mm
C	515mm-525mm
D	475mm-485mm

NO	ITEM	SPECIFICATION
1	PLYWOOD 9mm BACKREST	1 UNIT
2	FABRIC	
3	HI 1" FOAM	18-22 DENSITY
4	FABRIC	
5	HI 2" FOAM	18-22 DENSITY
6	PLYWOOD 9mm SEAT	1 UNIT
7	MS SCREW	
8	FRAME WITH EPOXY FINISH	1 UNIT
9	STACKING STUD	4 PCS.
10	PLASTIC STUD	4 PCS

DIMENSION

DIM	HIZ. IB.
A.	455mm-465mm
B.	905mm-915mm
C.	605mm-615mm

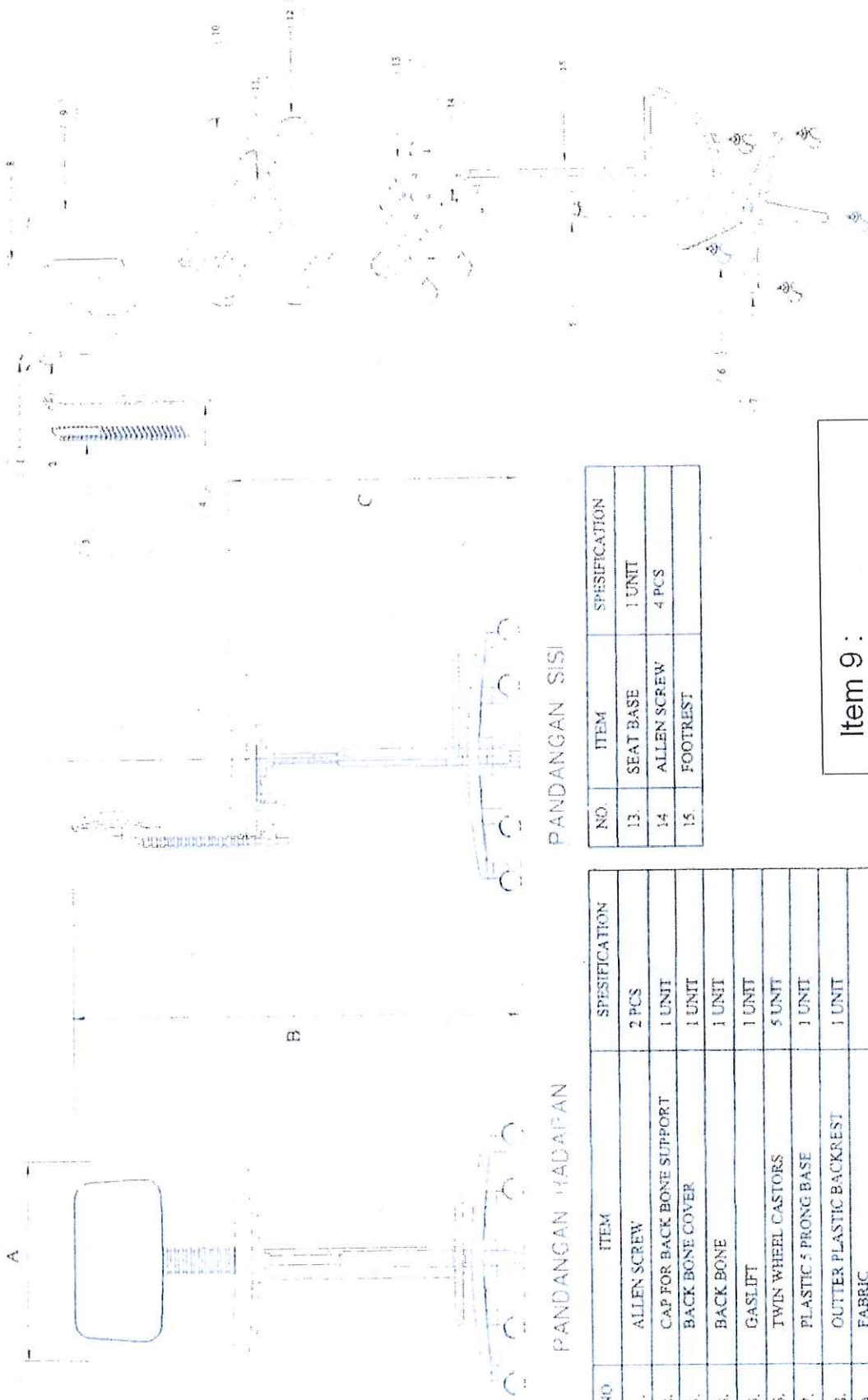

PANDANGAN MADAPAN

NO	ITEM	SPEFICATION
1.	ALLEN SCREW	2 PCS
2.	CAP FOR BACK BONE SUPPORT	1 UNIT
3.	BACK BONE COVER	1 UNIT
4.	BACK BONE	1 UNIT
5.	GASLIFT	1 UNIT
6.	TWIN WHEEL CASTORS	5 UNIT
7.	PLASTIC 5 PRONG BASE	1 UNIT
8.	OUTTER PLASTIC BACKREST	1 UNIT
9.	FABRIC	
10.	FABRIC	
11.	INNER PLASTIC SEAT	1 UNIT
12.	OUTER PLASTIC SEAT	1 UNIT

PANDANGAN SISI

NO.	ITEM	SPEFICATION
13.	SEAT BASE	1 UNIT
14.	ALLEN SCREW	4 PCS
15.	FOOTREST	

Item 9 :
Draughtman Chair

DIMENSION

DEM.	HIZ. 3
A.	610 - 650
B.	1120 MAX.
C.	610 - 630
D.	660 - 690
E.	550 MAX.

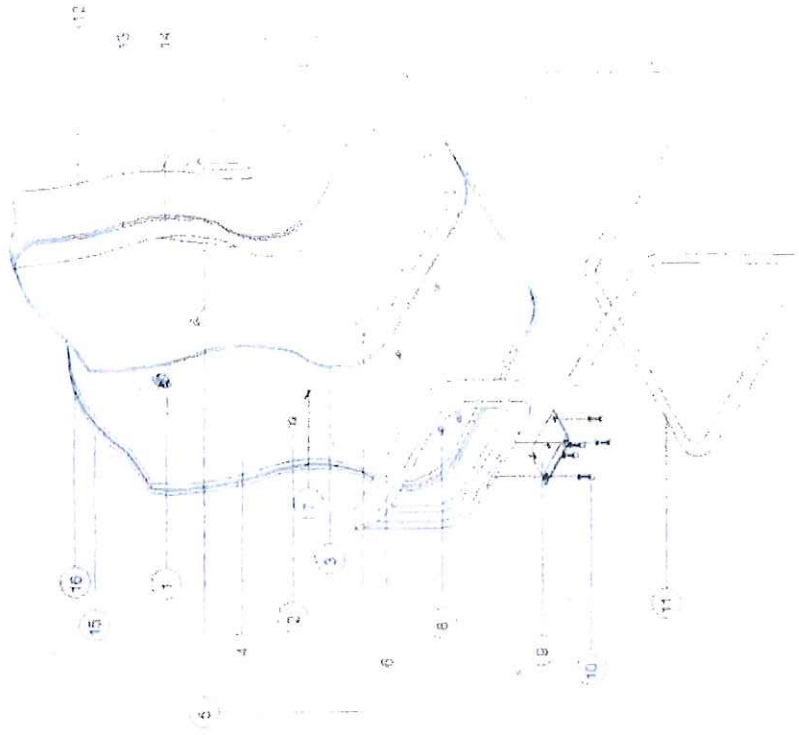

NO.	ITEM	SPECIFICATION
1.	FAST CLIP (FEMALE)	2 PCS.
2.	FAST CLIP (MALE)	2 PCS.
3.	PLYWOOD SHEEL INNER	4mm - 5mm THICKNESS
4.	PLYWOOD SHEEL OUTER	10mm - 14mm THICKNESS
5.	FOAM HI 1"	18 - 22 DENSITY
6.	PLASTIC ARMREST	2 PCS.
7.	TAPPING SCREW 1"	2 SET
8.	TEE NUT	12 PCS (6mm)
9.	ARMREST BRACKET	2 PCS
10.	ALEN SCREW	12 PCS
11.	FRAME	1 UNIT
12.	FABRIC	

NO.	ITEM	SPECIFICATION
13.	HI 4mm FOAM	18 - 22 DENSITY
14.	HI 2" FOAM	18 - 22 DENSITY
15.	KAIN HITAM	
16.	HI 4mm FOAM	18 - 22 DENSITY

Item 10 :
Cantilever Chair
C/O Arm

DIMENSION

DIM.	HIZ. 3
A	610 - 650
B	1120 MAX.
C	610 - 630
D	660 - 690
E	550 MAX.

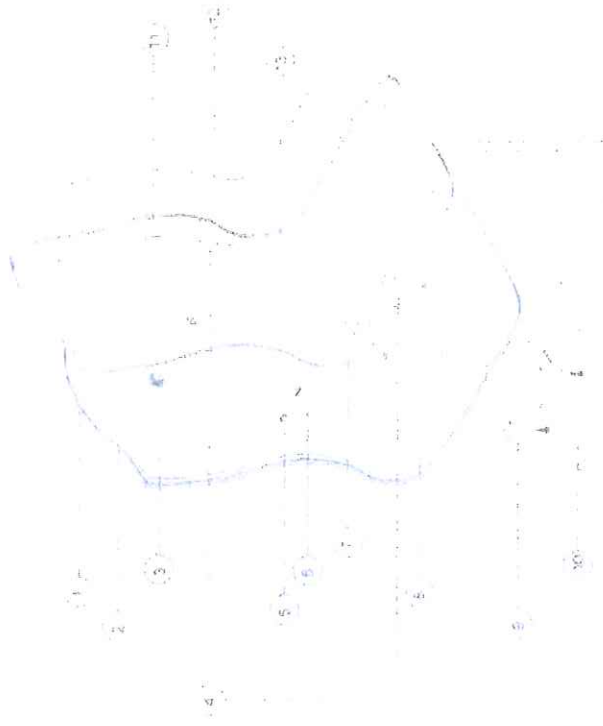
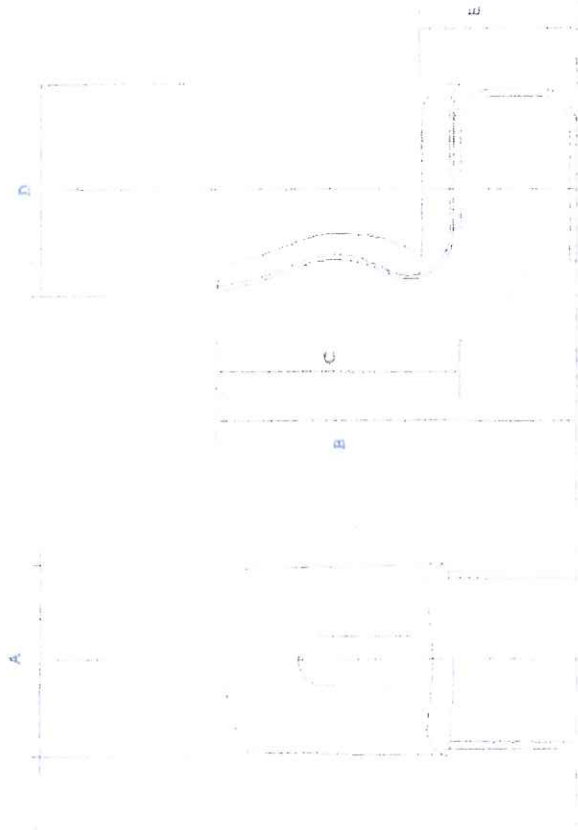

NO.	ITEM	SPECIFICATION
1	KAIN HITAM	
2	HJ 4mm FOAM	18-22 DENSITY
3	FAST CLIP (FEMALE)	2 PCS.
4	HI 1" FOAM	18-22 DENSITY
5	FAST CLIP (MALE)	2 PCS
6	TAPPING SCREW 1"	
7	PLYWOOD SHELL INNER	4mm-5mm THK.
8	PLYWOOD SHELL OUTER	10mm-14mm THK.
9	FRAME	EPOXY FINISH
10	MS SCREW	
11	HI 4mm FOAM	18-22 DENSITY
12	FABRIK	
13	HI 2" FOAM	18-22 DENSITY

Item 11 :
Cantilever Chair
W/O Arm

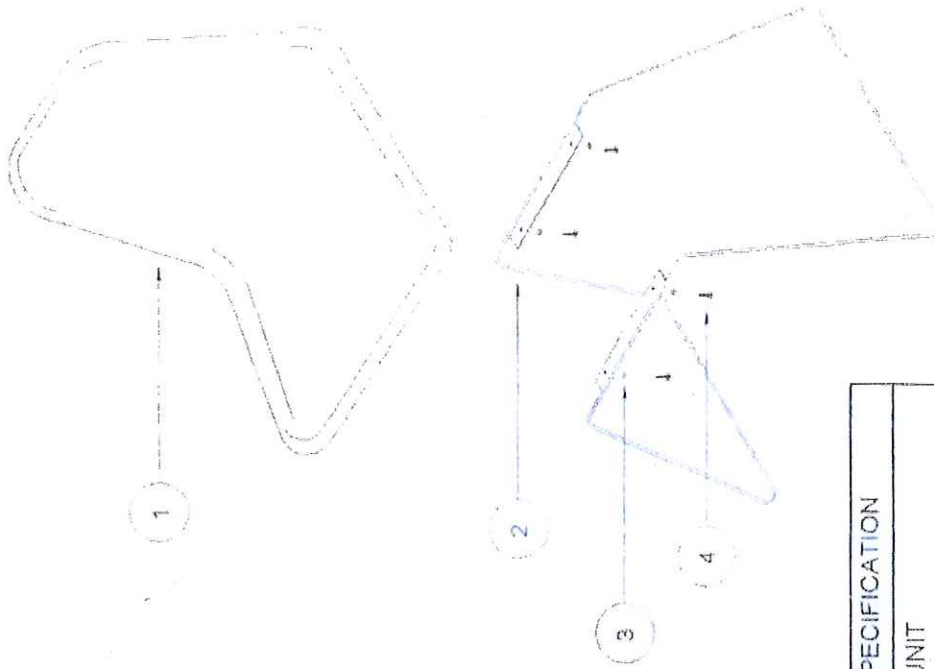
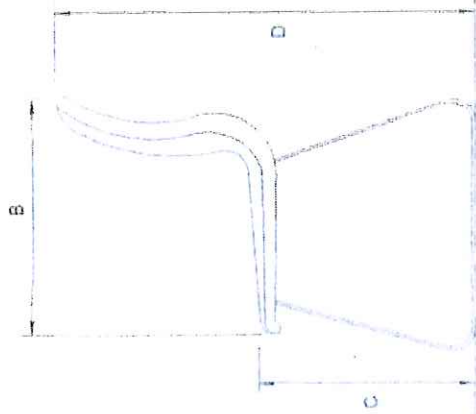
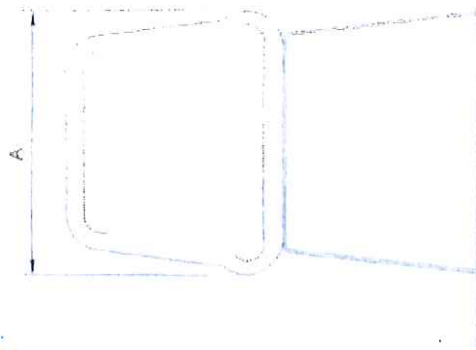

DIM	HIZ 10
A	465mm-475mm
B	515mm-525mm
C	695mm-705mm
D	425mm-435mm

DIM	ITEM	SPECIFICATION
1	SHELL COM/ FOAM AND FABRIC	1 UNIT
2	SOLID STEEL	9mm-11mm DIAMETER
3	SPRING WASHER	4 PCS.
4	MS SCREW	4 PCS.

Item 12 :
Skid Base Chair

- Item 13, 14 & 15 :
- Three Seater Sideshell Chair
C/W Fabric
 - Four Seater Sideshell Chair
C/W Fabric
 - Five Seater Sideshell Chair
C/W Fabric

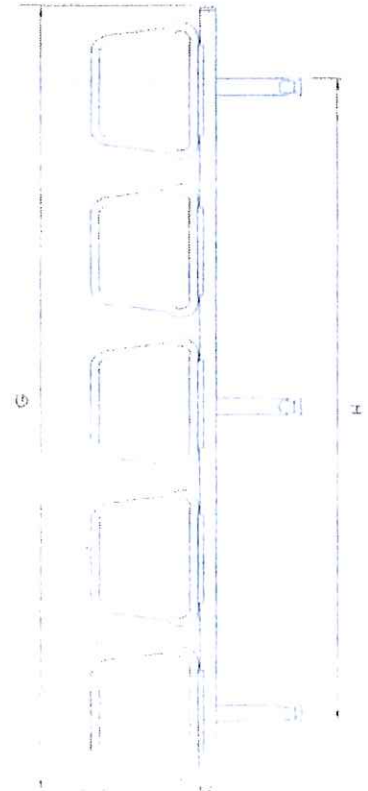
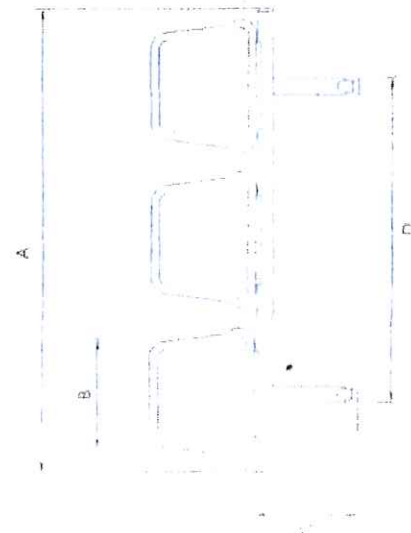

DIM	HIZ 11A,11B,11C
A	2027mm-2037mm
B	465mm-475mm
C	377mm-387mm
D	1775mm-1785mm
E	2308mm-2316mm
F	1900mm-1910mm
G	2382mm-2392mm
H	2962mm-2972mm
I	595mm-605mm
J	773mm-783mm
K	591mm-601mm

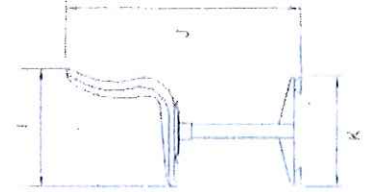
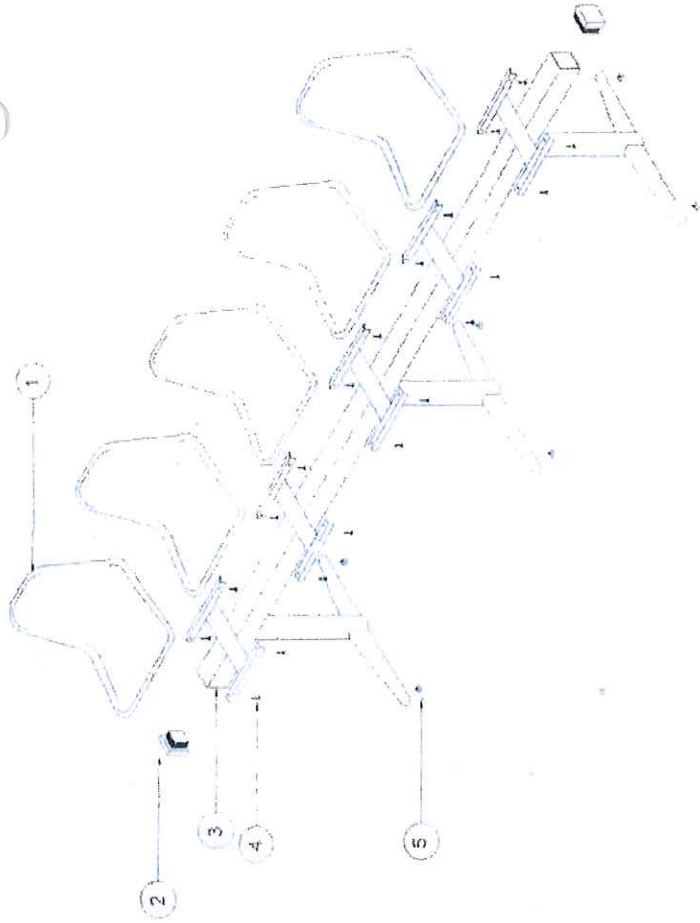

DIM	ITEM	SPECIFICATION
1	POLYPROPYLENE SIDESHELL	PLASTIC RESIN
2	RUBBER STUD	2 PCS.
3	MILD STEEL STAND	51mm X 51mm X 1.6mm
4	MS SCREW	
5	ADJUSTABLE GLIDERS	

Item 16 :
 Visitor Chair
 W/O Fabric

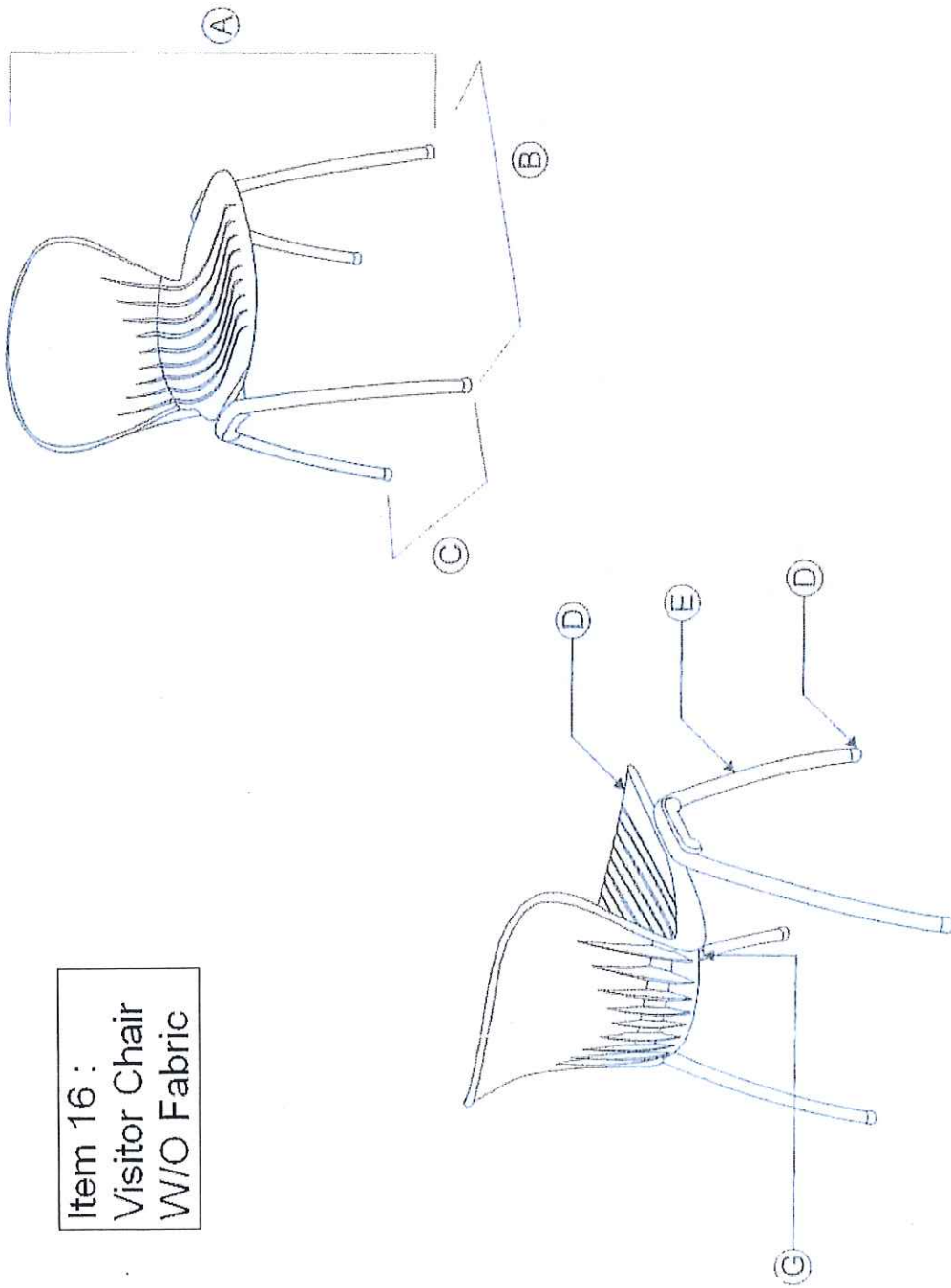

DIMENSION	
(A)	810mm (high)
(B)	490mm (width)
(C)	480mm (deep)
SPECIFICATION	
(D)	Polypropylene shell
(E)	Round tube in Epoxy powder coated
(F)	Rubber Stopper
(G)	Flexible Backrest

CONTRACTOR:	PROJECT & LOCATION:	DESIGNED BY:	DRAWN BY:	PROPOSED TITLE:	OWNER'S APPROVAL: APPROVED:	SHEET:
		CHECKED BY:	ISSUED DATE:			
		APPROVED BY:			(OWNER)	

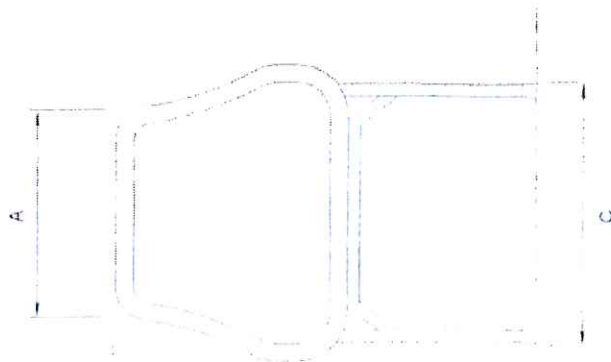

PANDANGAN HADAPAN

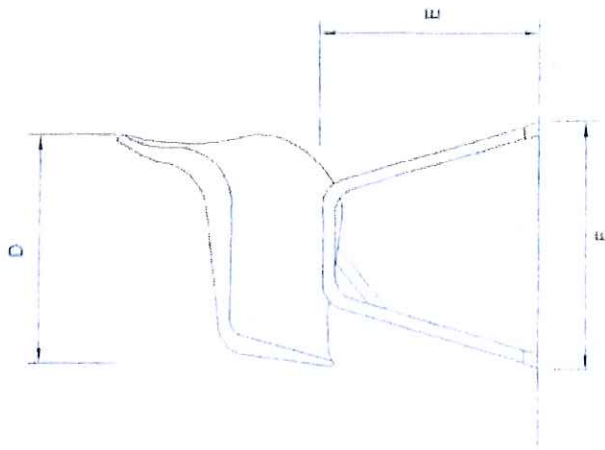

PANDANGAN SISI

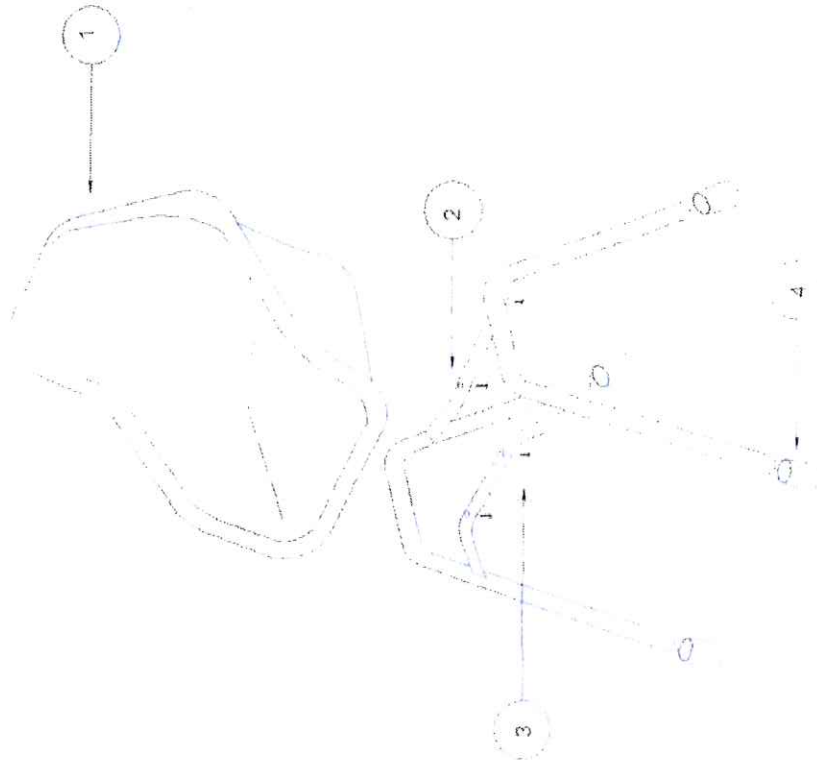

DIM	HIZ 11A,11B,11C
A	355mm-365mm
B	735mm-745mm
C	505mm-515mm
D	595mm-605mm
E	448mm-458mm
F	515mm-525mm

DIM	ITEM	SPECIFICATION
1	POLYPROPYLENE ARMSHELL	PLASTIC RESIN
2	MILD STEEL TUBE WITH EPOXY FINISH	
3	MS SCREW	
4	POLYPROPYLENE STUD	

Item 17 :
 Visitor Armshell Chair
 W/O Fabric

Item 18 :
Lecture Room Chair
C/W Fabric

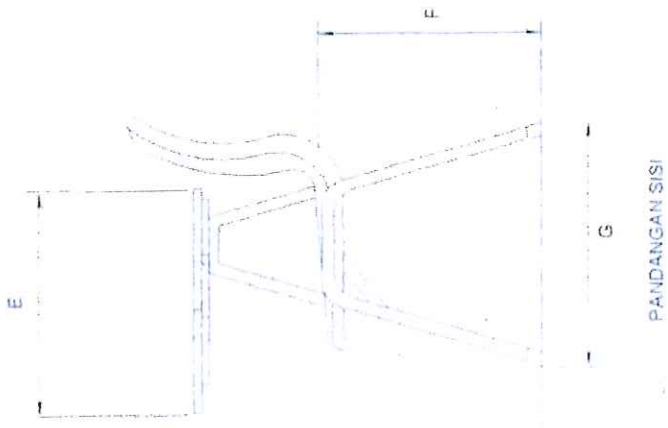
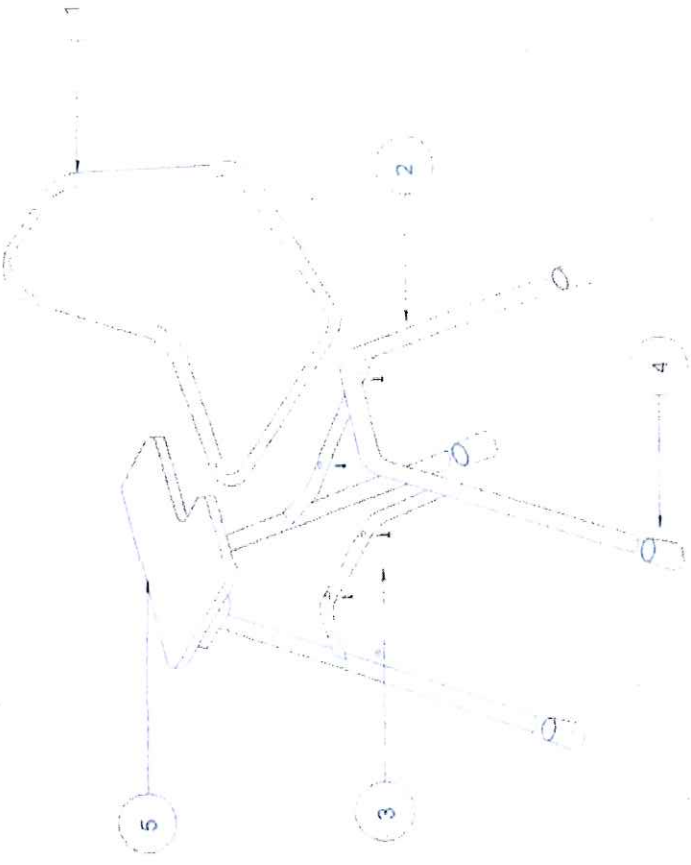

PANDANGAN SISI

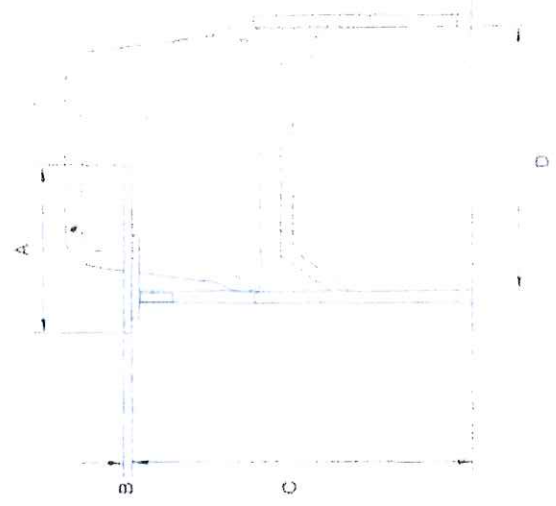

PANDANGAN HADAPAN

DIM	HIZ 14A
A	298mm-308mm
B	14mm-24mm
C	714mm-724mm
D	505mm-515mm
E	483mm-493mm
F	448mm-458mm
G	515mm-525mm

DIM	ITEM	SPECIFICATION
1	SHELL C/W FOAM AND FABRIC	
2	MILD STEEL TUBE	EPOXY FINISH
3	MS SCREW	
4	POLYPROPYLENE STUD	
5	MDF BOARD WITH SPRAY FINISH	17mm-19mm THK.

**Item 19 :
Lecture Room Chair
W/O Fabric**

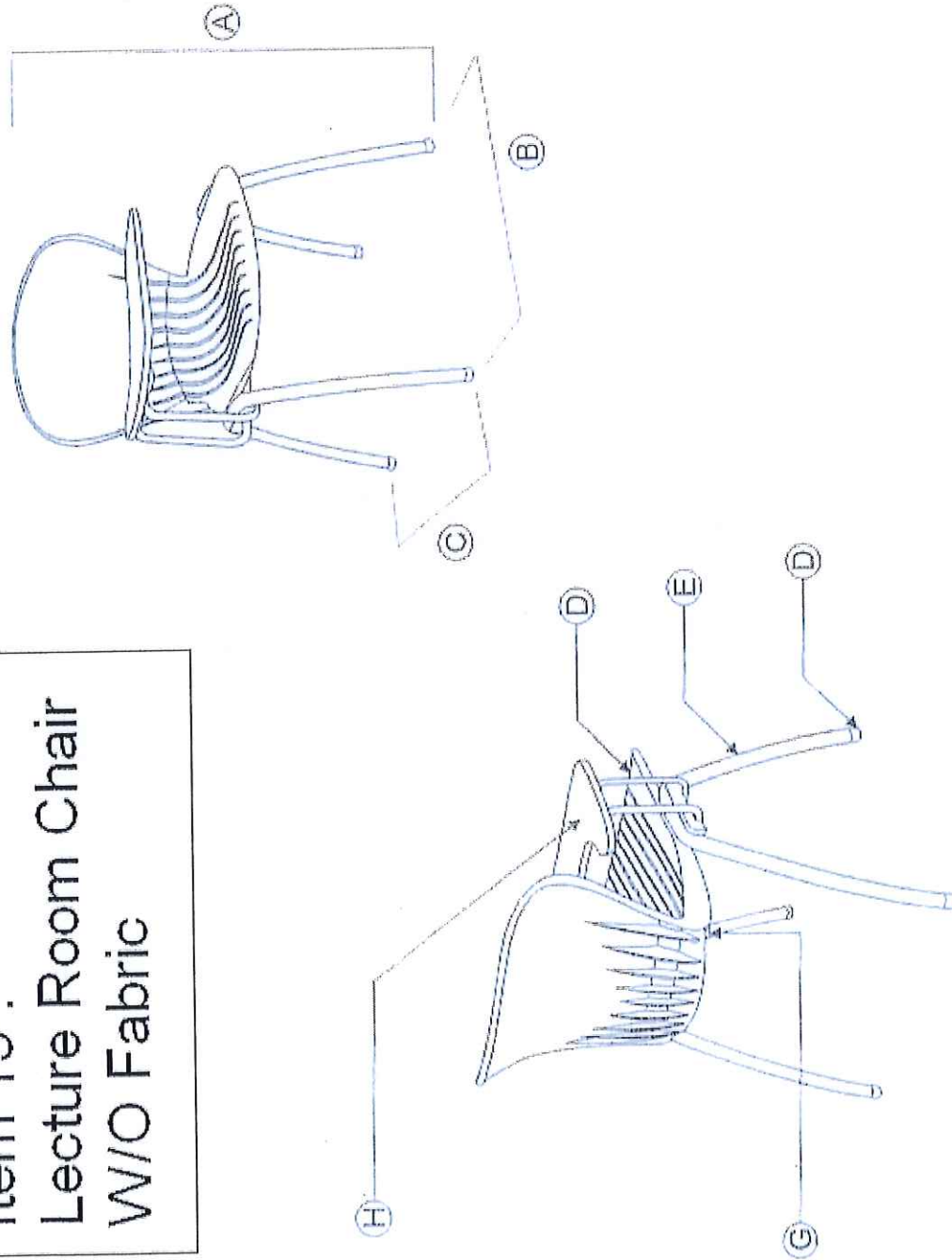

DIMENSION	
(A)	810mm (high)
(B)	490mm (width)
(C)	480mm (deep)
SPECIFICATION	
(D)	Polypropylene shell
(E)	Round tube in Epoxy powder coated
(F)	Rubber Stopper
(G)	Flexible Backrest
(H)	Writing Fold Arm c/w ABS Edging

CONTRACTOR:	PROJECT & LOCATION :	DESIGNED BY :	DRAWN BY :	PROPOSED TITLE:	OWNER'S APPROVAL:	SHEET :
		CHECKED BY :	ISSUED DATE:		APPROVED	
		APPROVED BY :				(OWNER)

Item 20, 21 & 22 :
 - Three Seater Sideshell Chair
 W/O Fabric
 - Four Seater Sideshell Chair
 W/O Fabric
 - Five Seater Sideshell Chair
 W/O Fabric

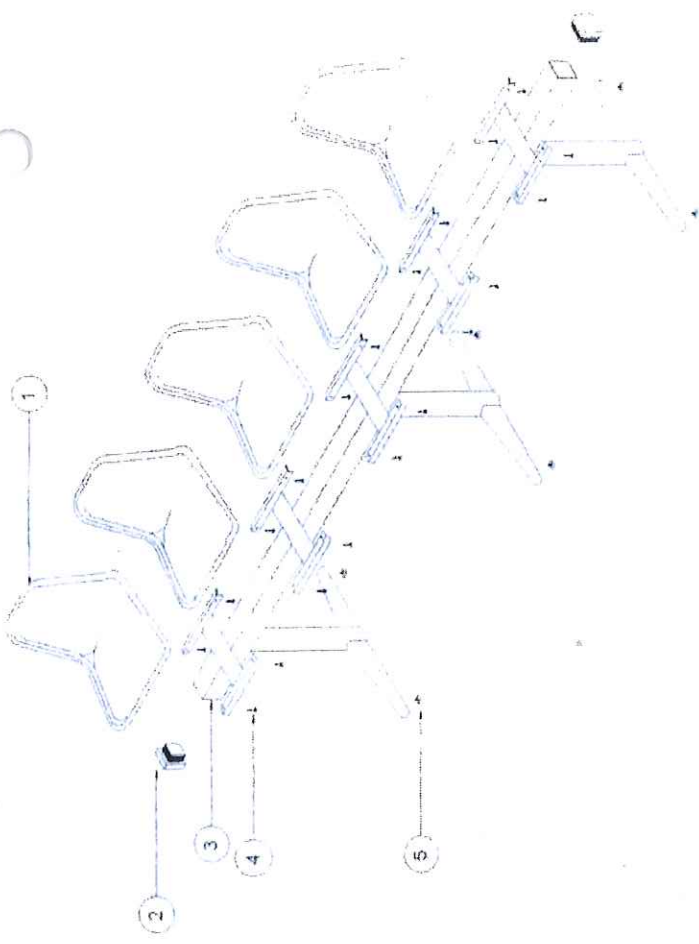

DIM	HIZ 11A, 11B, 11C
A	2027mm-2037mm
B	465mm-475mm
C	377mm-387mm
D	1775mm-1785mm
E	2306mm-2316mm
F	1900mm-1910mm
G	2392mm-2392mm
H	2962mm-2972mm
I	595mm-605mm
J	773mm-783mm
K	591mm-601mm

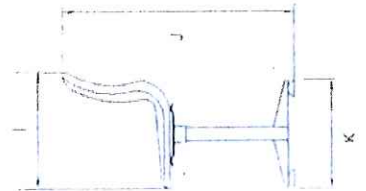
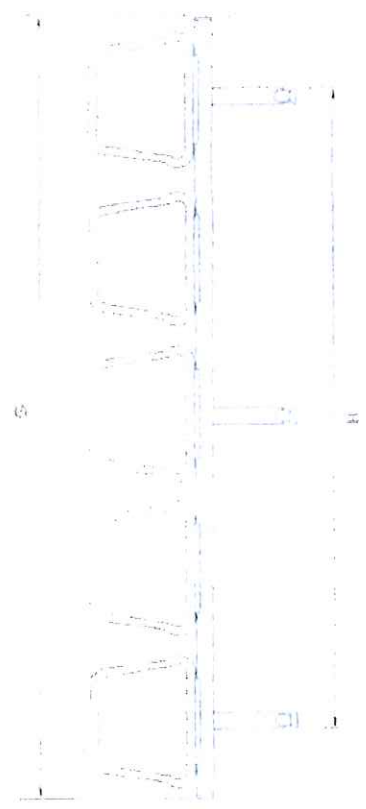
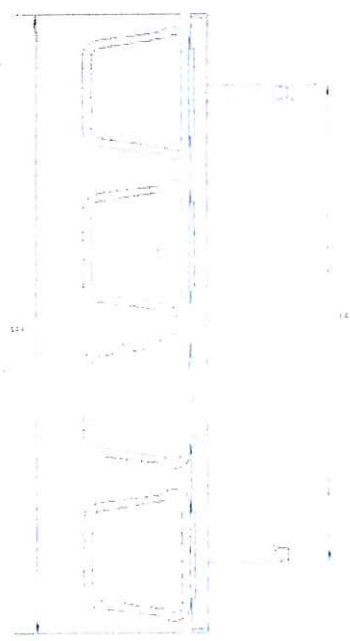
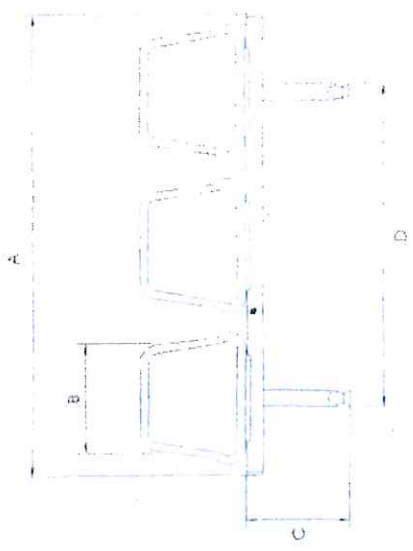

DIM	ITEM	SPECIFICATION
1	POLYPROPYLENE SIDESHELL	PLASTIC RESIN
2	RUBBER STUD	2 PCS.
3	MILD STEEL STAND	51mm X 51mm X 1.6mm
4	MS SCREW	
5	ADJUSTABLE GLIDERS	

PANDANGAN SS

PANDANGAN HADAPAN

Item 23, 24 & 25 :
 - Three Seater Armshell Chair
 W/O Fabric
 - Four Seater Armshell Chair
 W/O Fabric
 - Five Seater Armshell Chair
 W/O Fabric

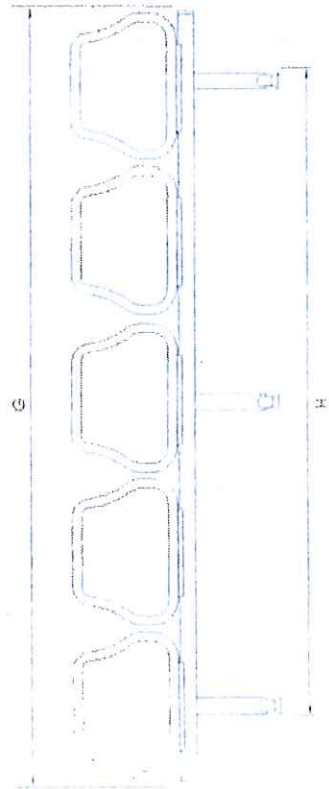
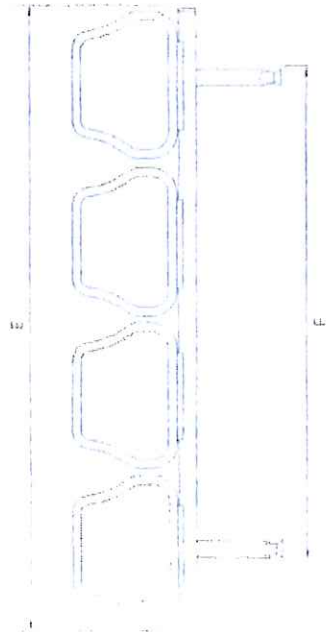
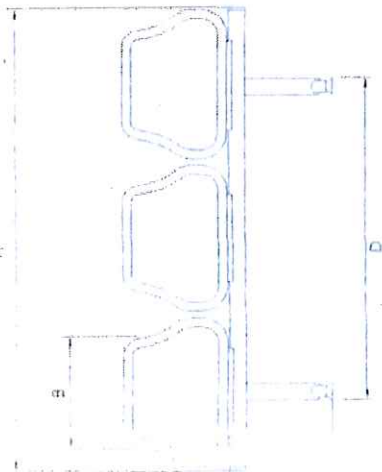

PANDANGAN HADAPAN



DIM	HIZ 11A, 11B, 11C
A	2027mm-2037mm
B	465mm-475mm
C	377mm-387mm
D	1775mm-1765mm
E	2306mm-2316mm
F	1900mm-1910mm
G	2382mm-2392mm
H	2962mm-2972mm
I	595mm-605mm
J	773mm-763mm
K	591mm-601mm

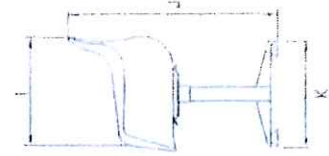

PANDANGAN SS

DIM	ITEM	SPECIFICATION
1	POLYPROPYLENE ARMSHELL	PLASTIC RESIN
2	RUBBER STUD	2 PCS
3	MILD STEEL STAND	51mm X 51mm X 1.6mm
4	MS SCREW	
5	ADJUSTABLE GLIDERS	

- Item 26, 27 & 28 :
- Sofa Single Seater
 - Sofa Double Seater
 - Sofa Triple Seater

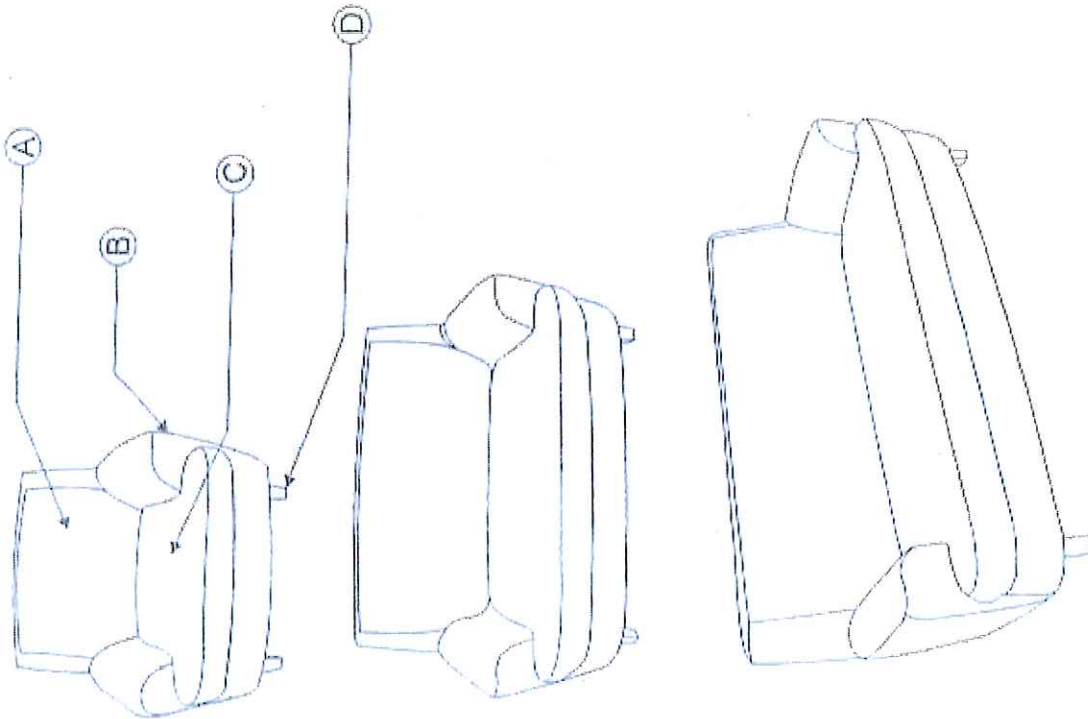

DIMENSION	H X W X D	
Single Seater	890 x 960 x 680mm	
Double Seater	890 x 1420 x 680mm	
Triple Seater	890 x 1800 x 680mm	
SPECIFICATION		
(A)	Selected Fabric & P.U.	
(B)	Hardwood	
(C)	Wooden Leg Spray Finished (Wood Grain)	
(D)	High Density Foam Finished	

CONTRACTOR:	PROJECT & LOCATION:	DESIGNED BY:	DRAWN BY:	PROPOSED TITLE:
		CHECKED BY:	ISSUED DATE:	
		APPROVED BY:		
OWNER'S APPROVAL:				SHEET:
APPROVED:				(OWNER)

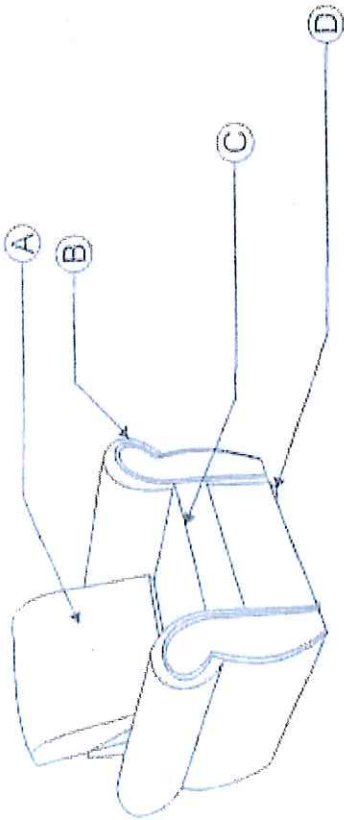

- Item 26, 27 & 28 :**
- Sofa Single Seater
 - Sofa Double Seater
 - Sofa Triple Seater

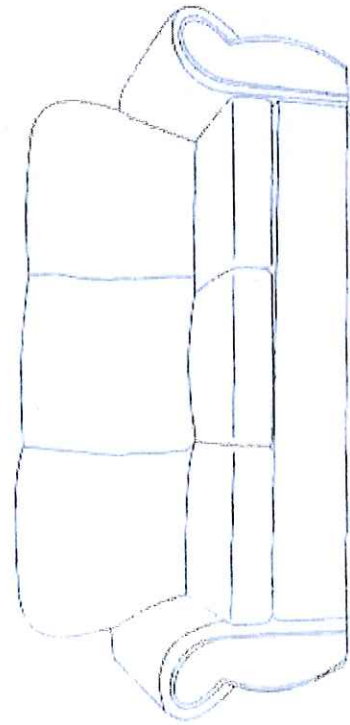
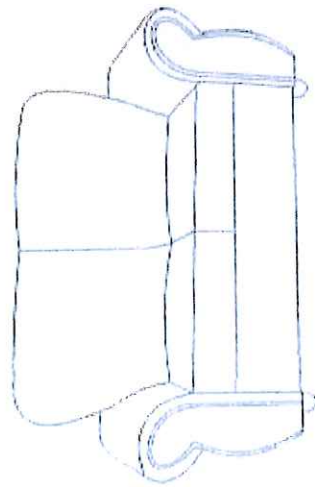

DIMENSION	L X W X D	
	Single Seater	40 x 31 x 36 inches
Double Seater	60 x 31 x 36 inches	
Triple Seater	80 x 31 x 36 inches	
SPECIFICATION		
(A)	Selected Fabric & P.U.	
(B)	Hardwood	
(C)	Wooden Leg Spray Finished (Wood Grain)	
(D)	High Density Foam Finished	

CONTRACTOR:	PROJECT & LOCATION:	DESIGNED BY:	DRAWN BY:	PROPOSED TITLE:	OWNERS APPROVAL: APPROVED:	SHEET
		CHECKED BY:	ISSUED DATE:			
		APPROVED BY:			(OWNER)	

Item 26, 27 & 28 :

- Sofa Single Seater
- Sofa Double Seater
- Sofa Triple Seater

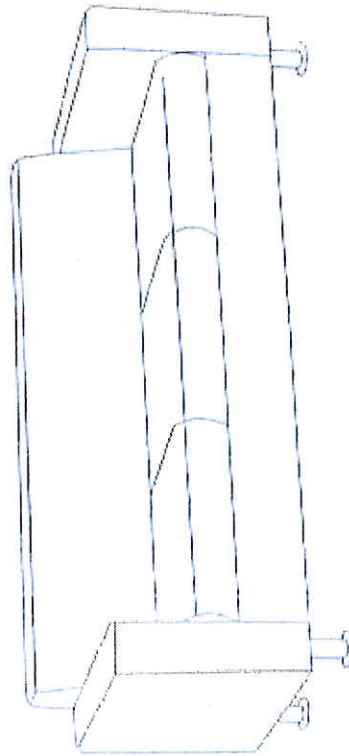
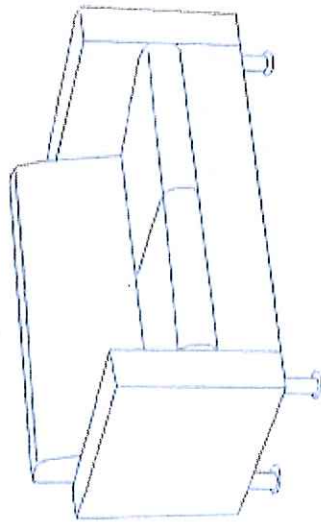
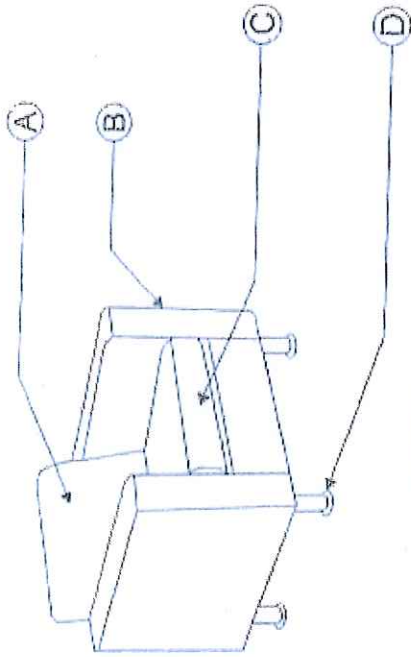

DIMENSION		H X W X D
Single Seater		750 x 800 x 730mm
Double Seater		750 x 1340 x 730mm
Triple Seater		750 x 1860 x 730mm
SPECIFICATION		
(A)	Selected Fabric & P.U.	
(B)	Hardwood	
(C)	Ø 50mm x H120mm Chrome Leg	
(D)	High Density Foam Finished	

CONTRACTOR: _____ PROJECT & LOCATION: _____	DESIGNED BY: _____	DRAWN BY: _____	PROPOSED TITLE: _____
	CHECKED BY: _____	ISSUED DATE: _____	OWNERS APPROVAL: APPROVED: _____
	APPROVED BY: _____		(OWNER)
			SHEET: _____

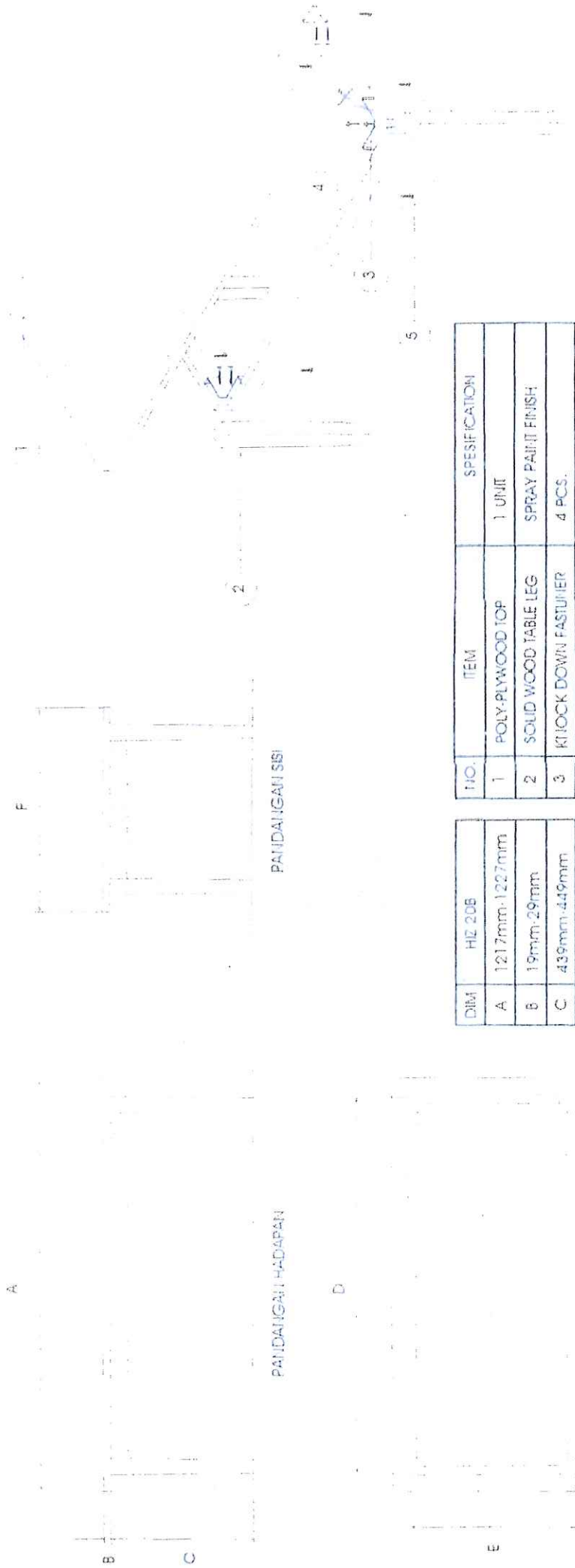

DIM	HIZ 20B
A	1217mm-1227mm
B	19mm-29mm
C	439mm-449mm
D	1117mm-1127mm
E	495mm-505mm
F	595mm-605mm

NO.	ITEM	SPEFICATION
1	POLY-PLYWOOD TOP	1 UNIT
2	SOLID WOOD TABLE LEG	SPRAY PAINT FINISH
3	KIT LOCK DOWN FASTENER	4 PCS.
4	JC-88	4 PCS.
5	SCREW	8 PCS.

Item 29 :
Coffee Table

Item 30 :
Side Table

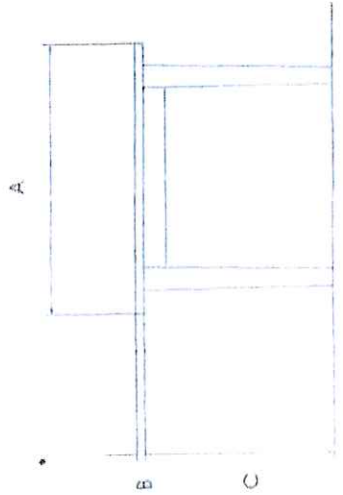

PANDANGAN HADAPAN

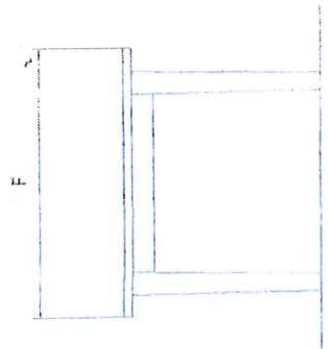

PANDANGAN SISI

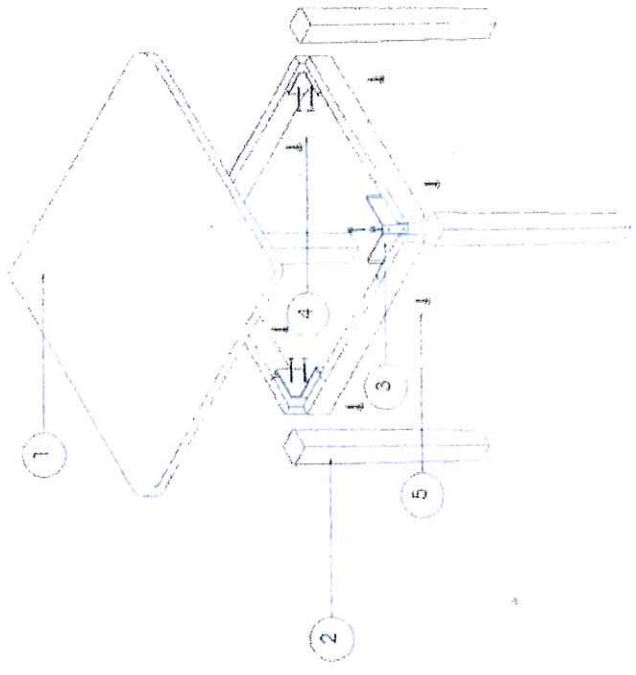

DIM	HIZ 208
A	495mm-505mm
B	19mm-29mm
C	439mm-449mm
D	495mm-505mm
E	495mm-505mm
F	595mm-605mm

NO.	ITEM	SPECIFICATION
1	POLY-PLYWOOD TOP	1 UNIT
2	SOLID WOOD TABLE LEG	SPRAY PAINT FINISH
3	KNOCK DOWN FASTENER	4 UNIT
4	JCBB	8 PCS.
5	SCREW	8 PCS.

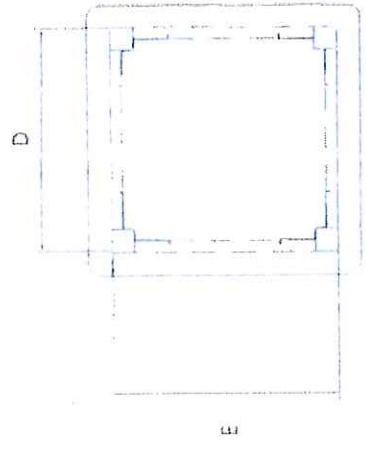

PANDANGAN PLAN

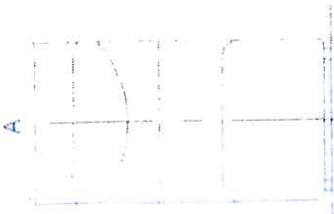

Item 31, 32 & 33 :
 Sette - Single Seater
 Sette - Double Seater
 Sette - Triple Seater

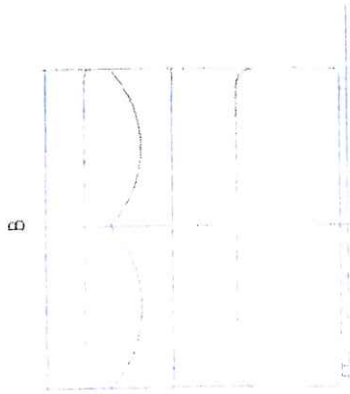

DIM	HIZ 21A, 21B, 21C
A	521mm-531mm
B	1029mm-1039mm
C	1537mm-1547mm
D	7869mm-7879mm
E	452mm-462mm

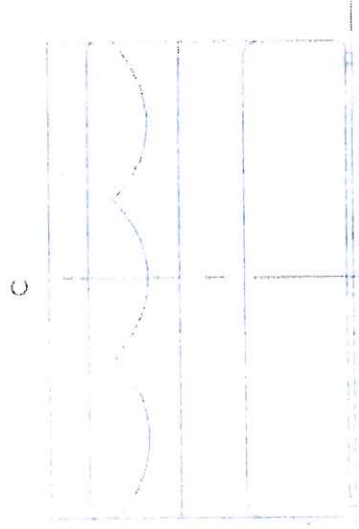

PANDANGAN HADAPAN

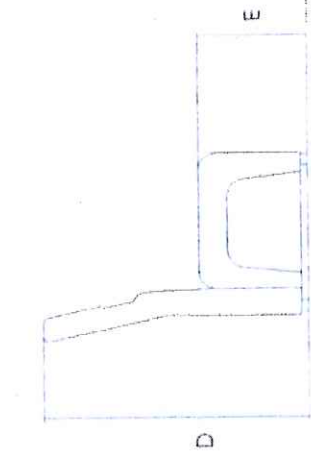
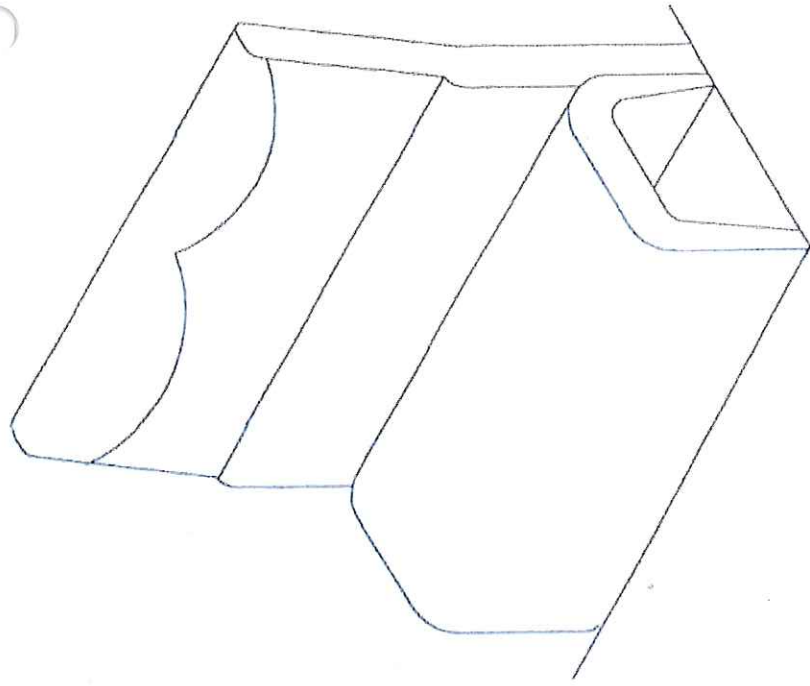

PANDANGAN SISI

NO	ITEM	SPECIFICATION
1	PANK	1" X 2"
2	PANK	2" X 2"
3	PLYWOOD	9mm
4	PLYWOOD	4mm
5	FOAM SOFT	2" 18-22 DENSITY
6	FOAM HI	2" 18-22 DENSITY
7	FOAM HI	1.5" 18-22 DENSITY
8	FOAM HI	8mm 18-22 DENSITY
9	FABRIC/PVC	

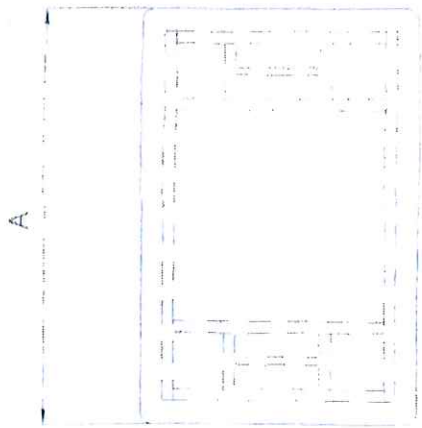

PANDANGAN PULAU

DIM	MEJA SERBAGUNA 2X3'
A	909.4mm-919.4mm
B	747mm-757mm
C	604.6mm-614.6mm
DIM	MEJA SERBAGUNA 2X6'
A	1823.8mm-1833.8mm
B	747mm-757mm
C	604.6mm-614.6mm
DIM	MEJA SERBAGUNA 3X5'
A	1519mm-1529mm
B	747mm-757mm
C	909.4mm-919.4mm
DIM	MEJA SERBAGUNA 3X3'
A	909.4mm-919.4mm
B	747mm-757mm
C	909.4mm-919.4mm

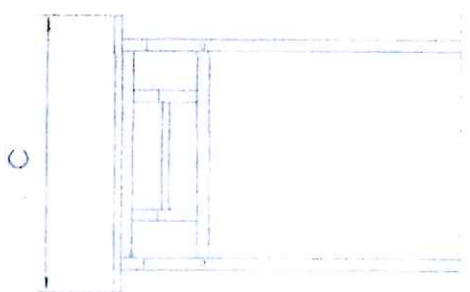

PANDANGAN SISI



PANDANGAN HADAPAN

Item 34,35,36,37,38,39,40 & 41 :
Meja Serbaguna
2' x 3'
2' x 6'
3' x 5'
3' x 3'

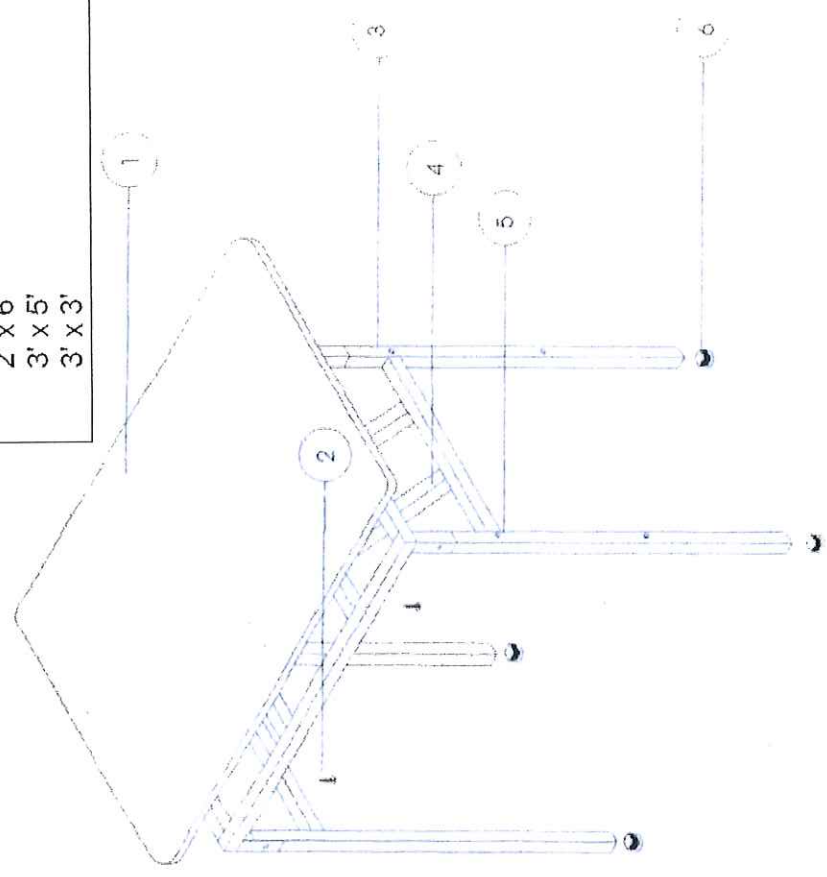

DIM	ITEM	SPECIFICATION
1	POLY-PLYWOOD TOP	1 UNIT
2	MS SCREW	6 PCS.
3	FRAME	1 UNIT
4	BRACKET	4 PCS
5	STAKING STUD	8 PCS
6	PLASTIC STUD	4 PCS

PICTURE

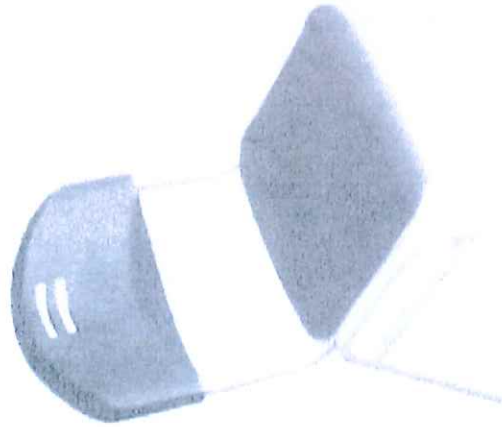

SPECIFICATION

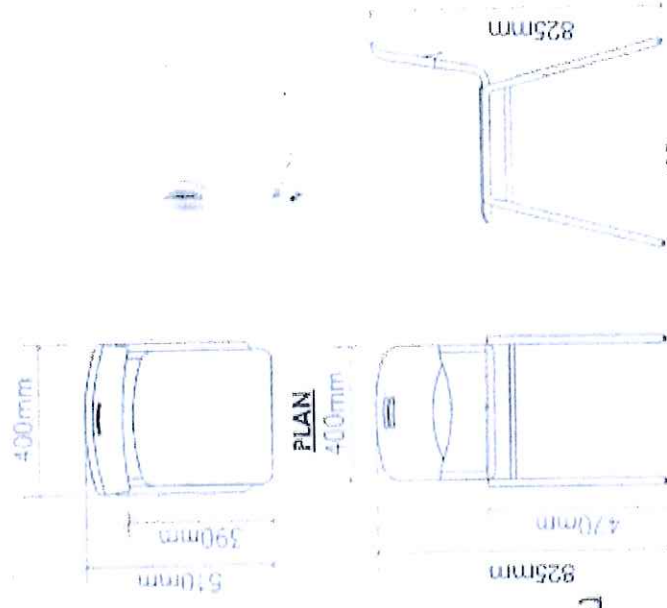

SPECIFICATION

DIMENSION
400mm X 510mm X 825mm

SEAT
- 5.4mm thk plastic polypropylene
WEIGHT (SEAT POLYPROPYLENE)
- 580gm (-5%)

BACKREST
- 3.7mm thk plastic polypropylene
WEIGHT (BACKREST POLYPROPYLENE)
- 340gm (+5%)

COLOUR POLYPROPYLENE

PP-72025-PT101P101/MP

FRAME
- square hollow mild steel 19mm x 19mm x 1.2mm thk with epoxy powder coating.

STOPPER
-Round stopper

CERTIFICATED / KESELAMATAN
Wajib mendapat kelulusan daripada FRIM / FITEC / MTIB

FRONT ELEVATION

SIDE ELEVATION

PROJECT :

PERABOT SEKOLAH MENENGAH

KOD ITEM

SD 107

MODEL

SD 107

Item 42 :

**Kerusi Murid
(Menengah/Rendah)**

DRAWN BY:

CHECKED BY:

DATE:

SCALE:

PICTURE

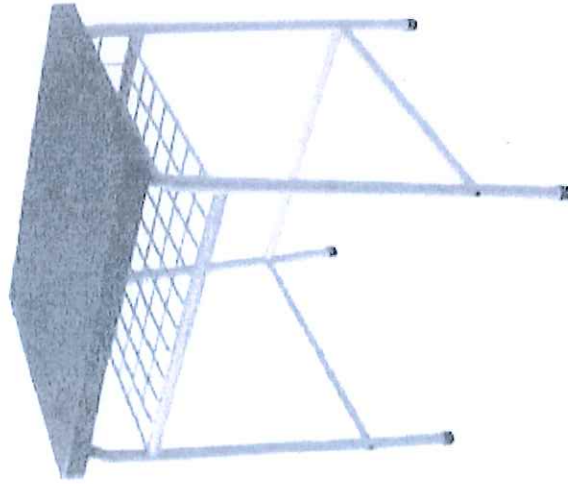

SPECIFICATION

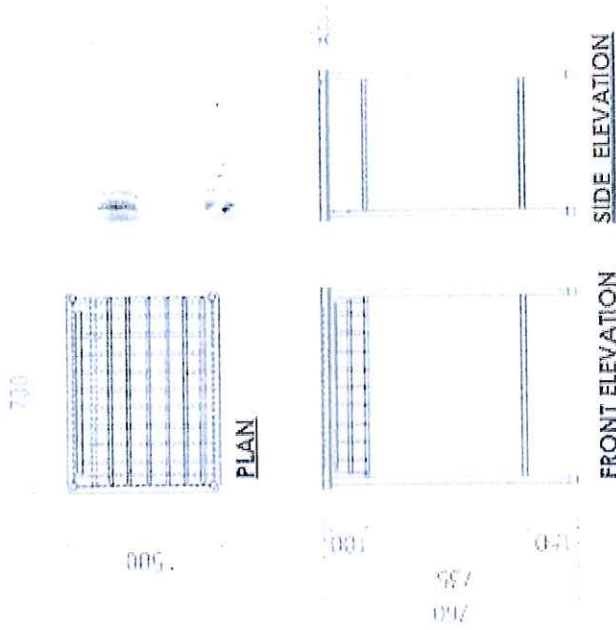

SPECIFICATION

DIMENSION

700mm X 500mm X 760mm

TABLE TOP

- 5mm thk plastic polypropylene

SIDE TABLE TOP

- 6mm thk plastic polypropylene

WEIGHT (TABLE TOP)

- 2 kg (+5%)

COLOUR POLYPROPYLENE

PP-72025-PT110P101/MP

FRAME

- steel hollow tube
dia. 19mm x 1.2mm thk with epoxy powder coating.

STOPPER

-Round stopper

CERTIFICATED / KESELAMATAN

Wajib mendapat kelulusan daripada FRIM / FITEC / MTIB

PROJECT :

PERABOT SEKOLAH MENENGAH

KOD ITEM

MP / ST POLY - ED 115

MODEL

MP / ST POLY - ED 115

DRAWN BY:

CHECKED BY:

DATE:

SCALE:

Item 43 :

**Meja Murid
(Menengah/Rendah)**

Item 44 & 45 :
 Meja Bulat Serbaguna
 - 1800 Diameter-Untuk 10 Orang
 - 1500 Diameter-Untuk 8 Orang

25mm x 2mm ABS EDGE

Spring

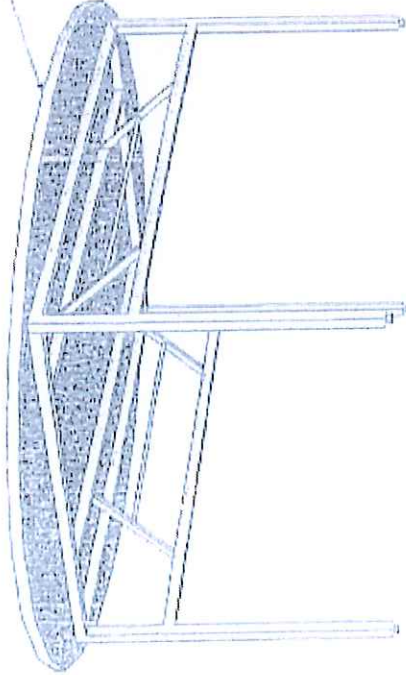

25mm

DIA 1500mm

Foldable Round Table
 (H1500mm x D1500mm x H750mm)

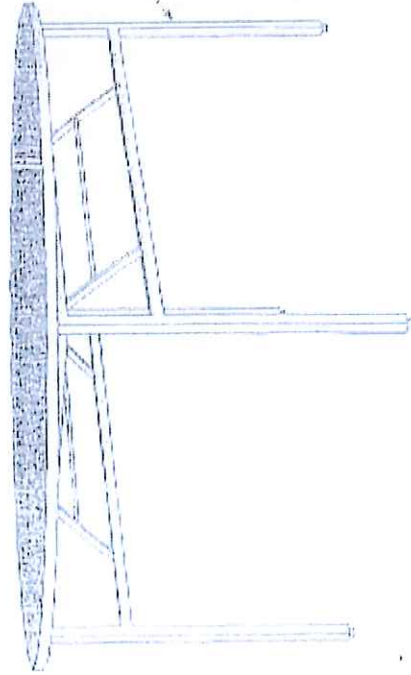

Specification

Dimension: 1500WX 1500D X 750H - (Round)

Worktop : 25mm Poly Ply c/w ABS Edging

Leg: 25mm Mild steel Black Epoxy Powder Coated c/w Adjustable Base & Double Spring

CONTRACTOR:

PROJECT & LOCATION:

DESIGNED BY:

DRAWN BY:

PROPOSED TITLE:

CHECKED BY:

ISSUED DATE:

FOLDABLE ROUND TABLE

OWNER'S APPROVAL:

APPROVED:

SHEET

(OWNER)

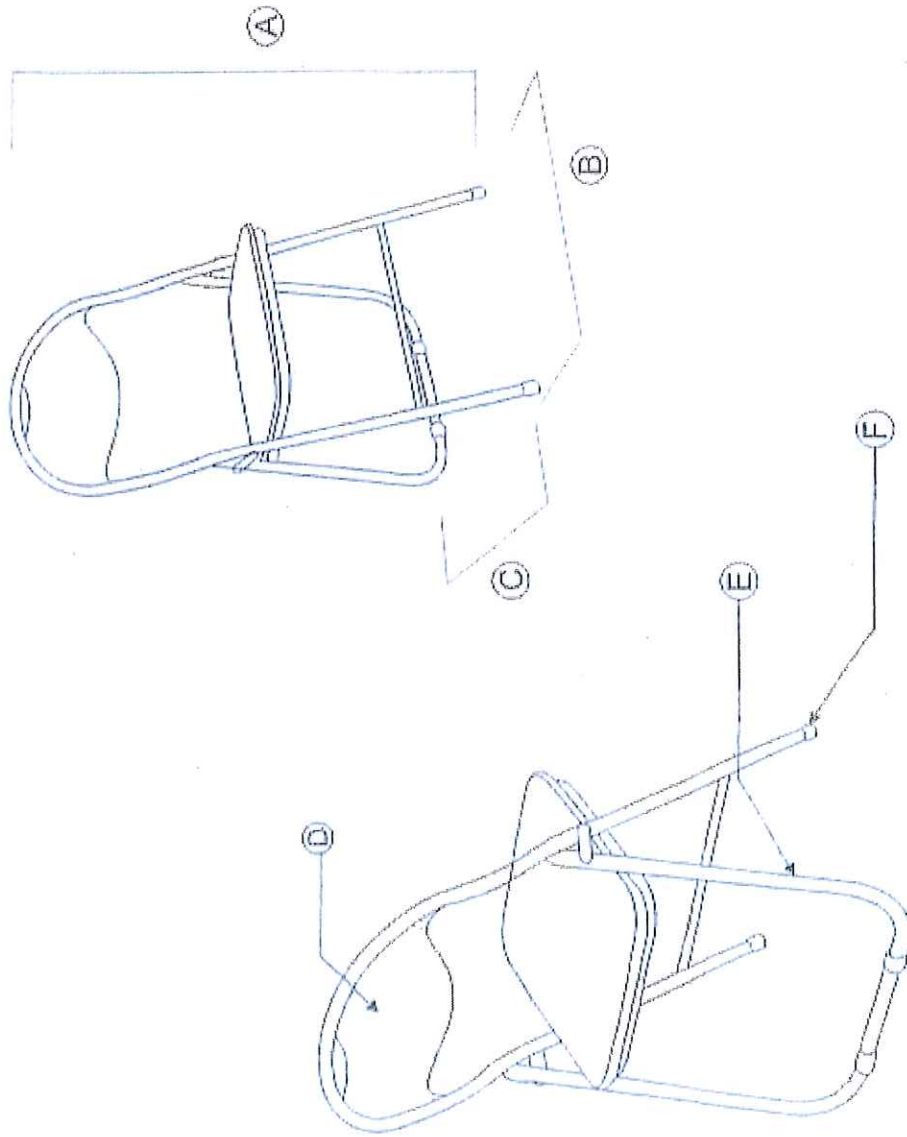

Folding Chair

DIMENSION	
(A)	780mm (H)
(B)	375mm (W)
(C)	400mm (L)
SPECIFICATION	
(D)	Epoxy / PVC selected
(E)	Chrome Tube
(F)	Rubber Stopper

CONTRACTOR:	PROJECT & LOCATION:	DESIGNED BY:	DRAWN BY:	Item 46 : Folding Chair	OWNER'S APPROVAL: APPROVED:	SHEET:
		CHECKED BY:	ISSUED DATE:		(OWNER)	
		APPROVED BY:				

B7-KERUSI GURU
Code : PPP06

Dimensi : 480W x 500D x 900H

Penyandar dan tempat
duduk berspan lembut
(polypropylene foam)

Kaki kerusi dibuat daripada
keluli berketumpatan sederhana
(mild steel) disalut dengan epoxy
powder coat

Item 47 :
Kerusi Guru

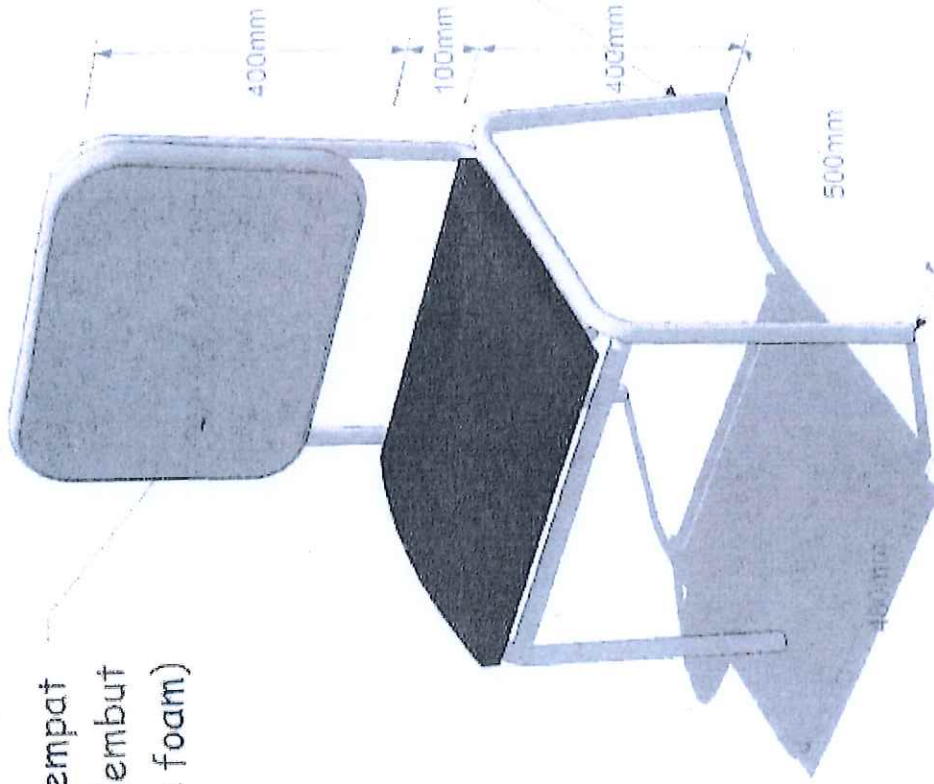

Pandangan 3D

COMPUTER TABLE C/W CPU HOLDER
(1050mm x 750mm x 750mm)

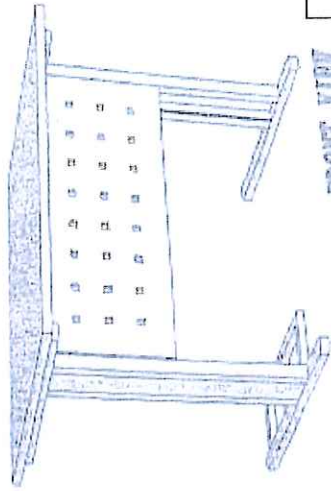
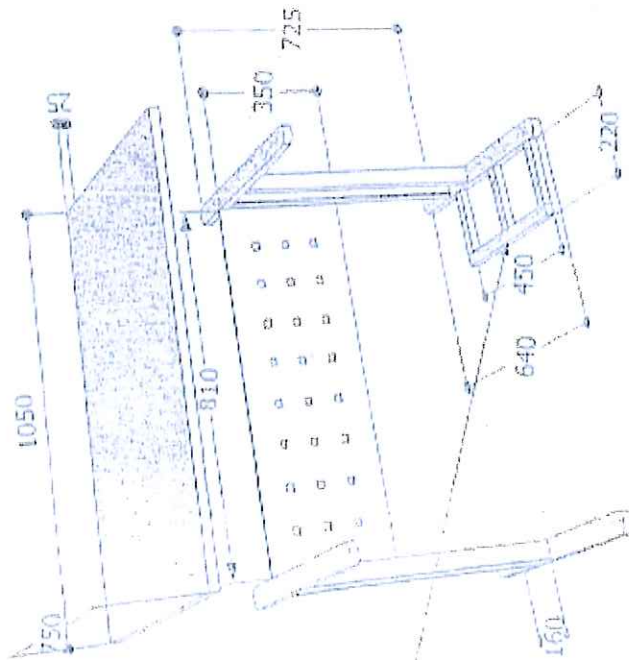

FRONT VIEW

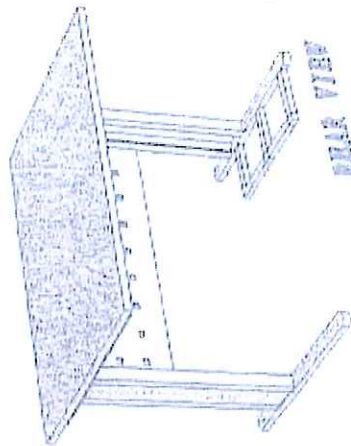

REAR VIEW

Item 48 :
Computer Table
C/W CPU Holder

Specification

Dimension :	1050W X 750D X 750H
Worktop :	25mm Melamine Chipboard c/w ABS Edging
Metal Base :	Wire Management Metal Leg c/w CPU Holder - Epoxy Powder Coated
Panel :	Metal Modesty Panel - Epoxy Powder Coated

CONTRACTOR:

PROJECT & LOCATION:

DESIGNED BY:

CHECKED BY:

APPROVED BY:

DRAWN BY:

ISSUED DATE:

PROPOSED TITLE:

COMPUTER TABLE

OWNER'S APPROVAL:

APPROVED:

SHEET:

(OWNER)

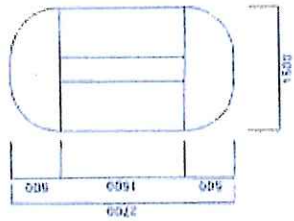
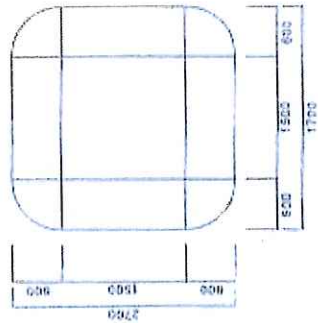
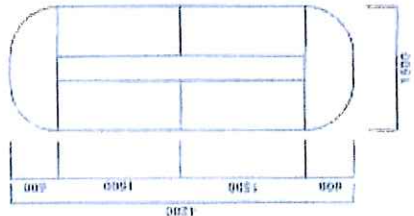
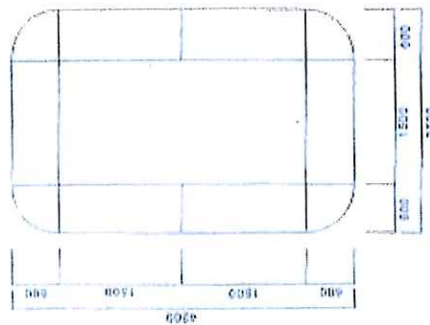
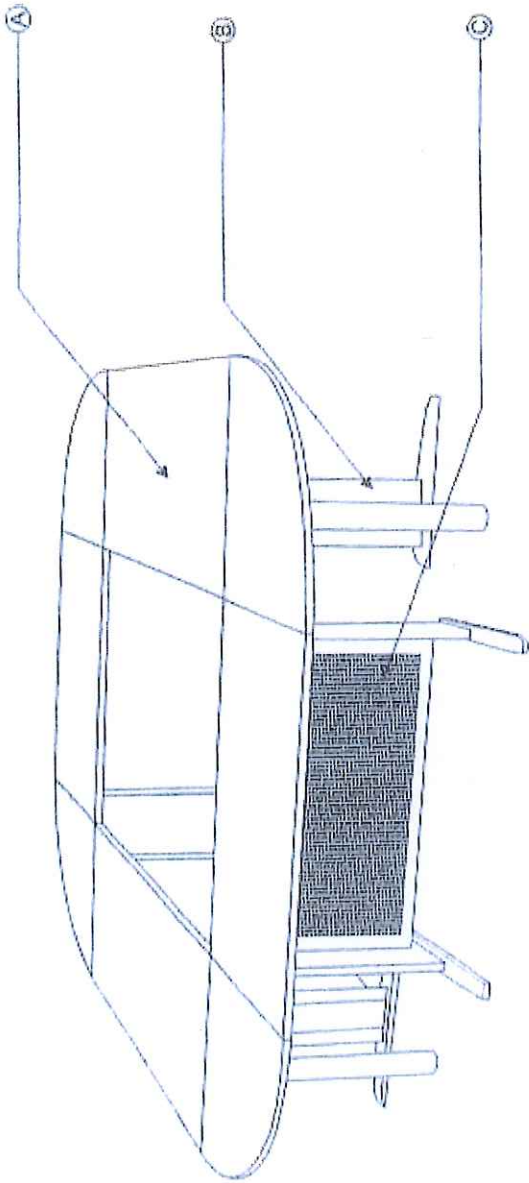

SPECIFICATION

- (A) Top surface : 25mm thk. Melamine Chipboard
- (B) Leg: Epoxy Steel Leg
- (C) Panel: Epoxy Steel Modesty Panel

CONTRACTOR:	PROJECT & LOCATION:	DESIGNED BY:	DRAWN BY:	OWNER'S APPROVAL:	SHEET:
		CHECKED BY:	ISSUED DATE:	APPROVED:	
		APPROVED BY:		[OWNER]	

**Item 49,50,51&52:
Meeting Table**

Item 53 :
Pra Sekolah
Kerusi Murid

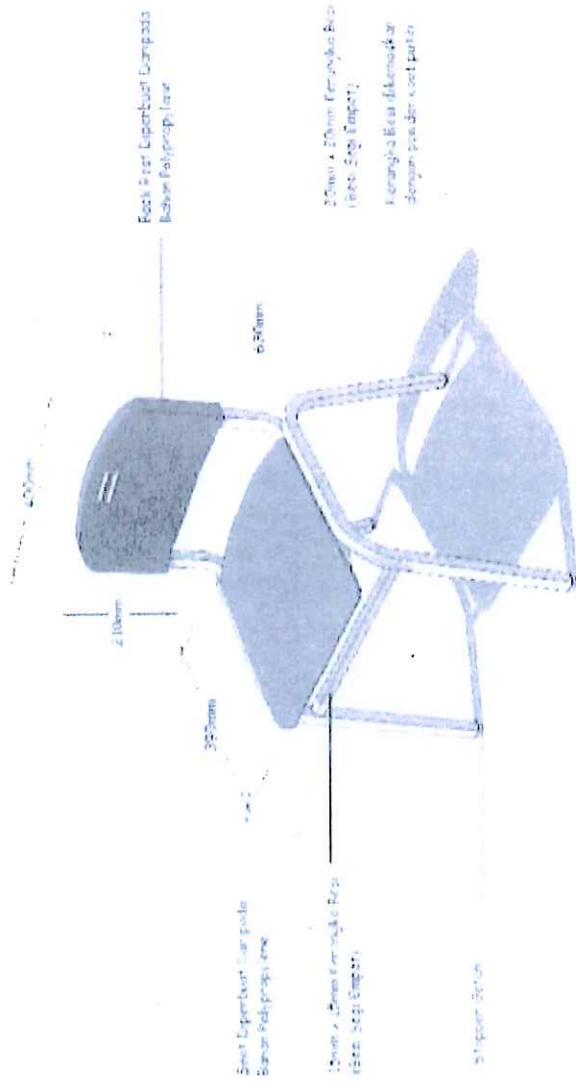

PANDANGAN ISOMETRIC

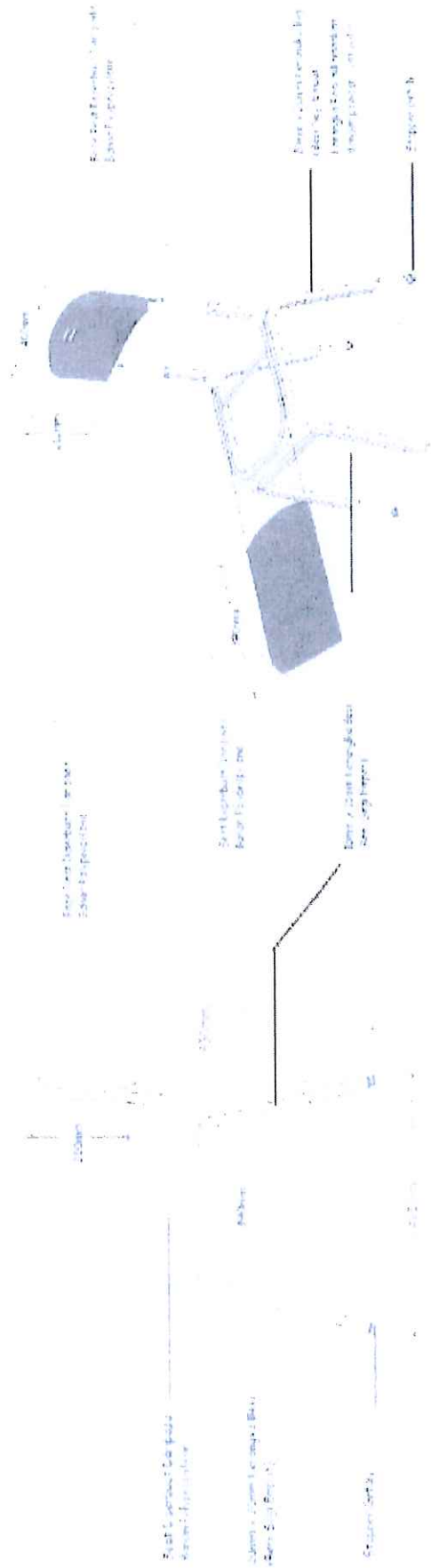

PANDANGAN SISI

PANDANGAN TERCERAI

**Item 54 :
Pra Sekolah
Meja Trapezium**

B1-MEJA TRAPEZIUM
Code : PPP01

Ketebalan meja 18mm diperbuat daripada melamine laminated chipboard

Bucu dan sisi dikemaskan dengan 2mm PVC untuk menjamin keselamatan

Kaki meja diperbuat daripada besi bergaris pusat 50mm

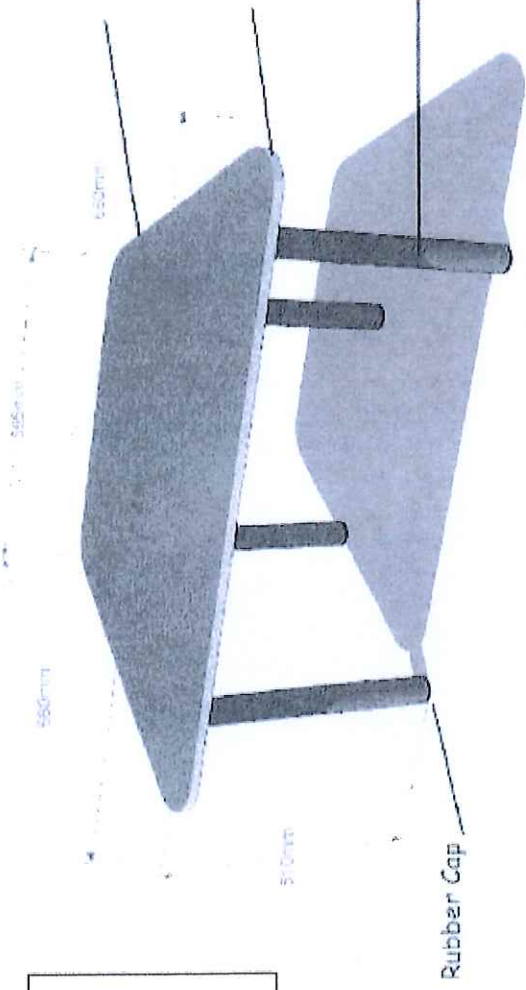

PANDANGAN ISOMETRIC

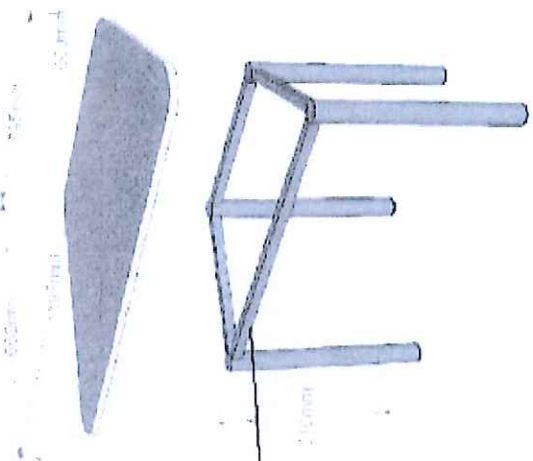

PANDANGAN TERCERAI

Rangka meja diperbuat daripada besi segiempat 25mm

*semua bahagian besi dikemaskan dengan epoxy powder coat warna kelabu gelap

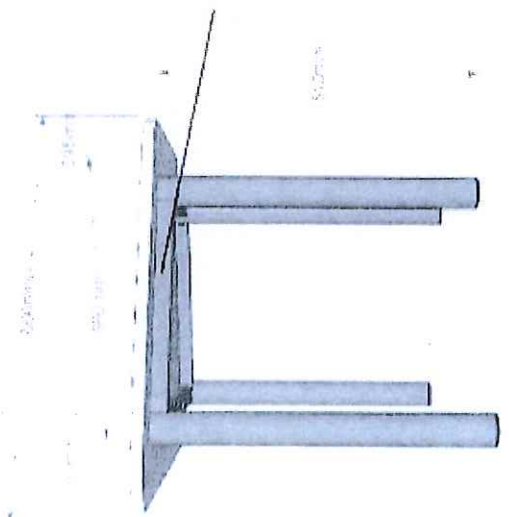

PANDANGAN SISI

**Item 55 :
Pra Sekolah
Meja Rectangular**

B2-MEJA RECTANGULA

Code : PPP02

Ketebalan meja 18mm diperbuat daripada melamine laminated chipboard

Bucu dan sisi dikemaskan dengan 2mm PVC untuk menjamin keselamatan

Kaki meja diperbuat daripada besi bergaris pusat 50mm

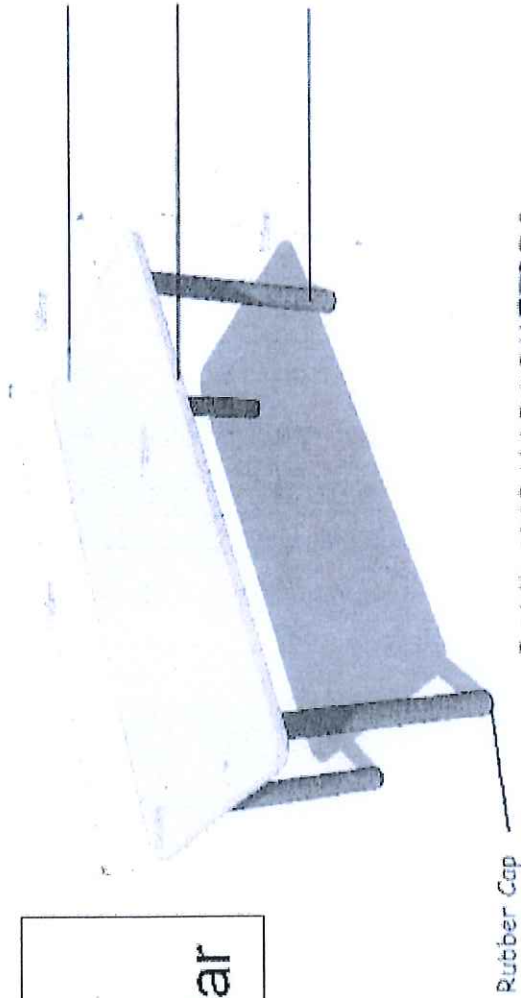

PANDANGAN ISOMETRIC

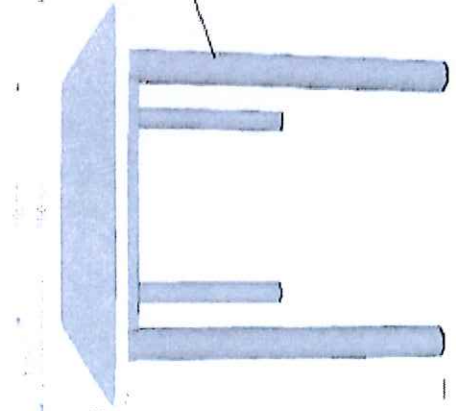

PANDANGAN SISI

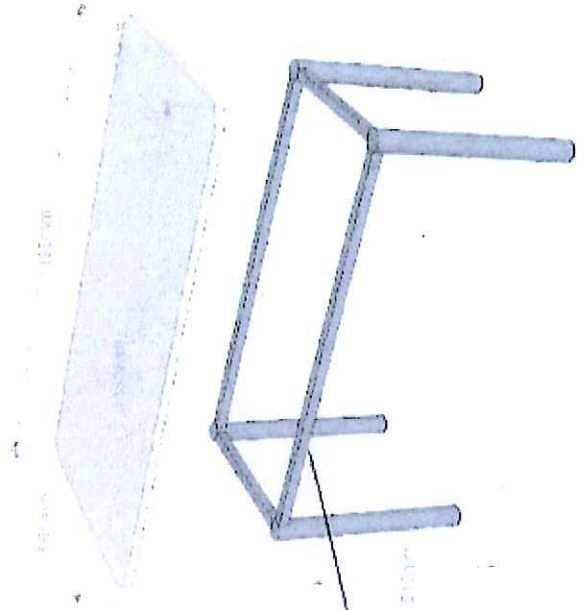

PANDANGAN TERCERAI

Kaki meja diperbuat daripada besi bergaris pusat 50mm

Rangka meja diperbuat daripada besi segiempat 25mm

* semua bahagian besi dikemaskan dengan epoxy powder coat warna kelabu gelap

B3-MEJA BULAT

Code : PPO3

Item 56 :
Pra Sekolah
Meja Bulat

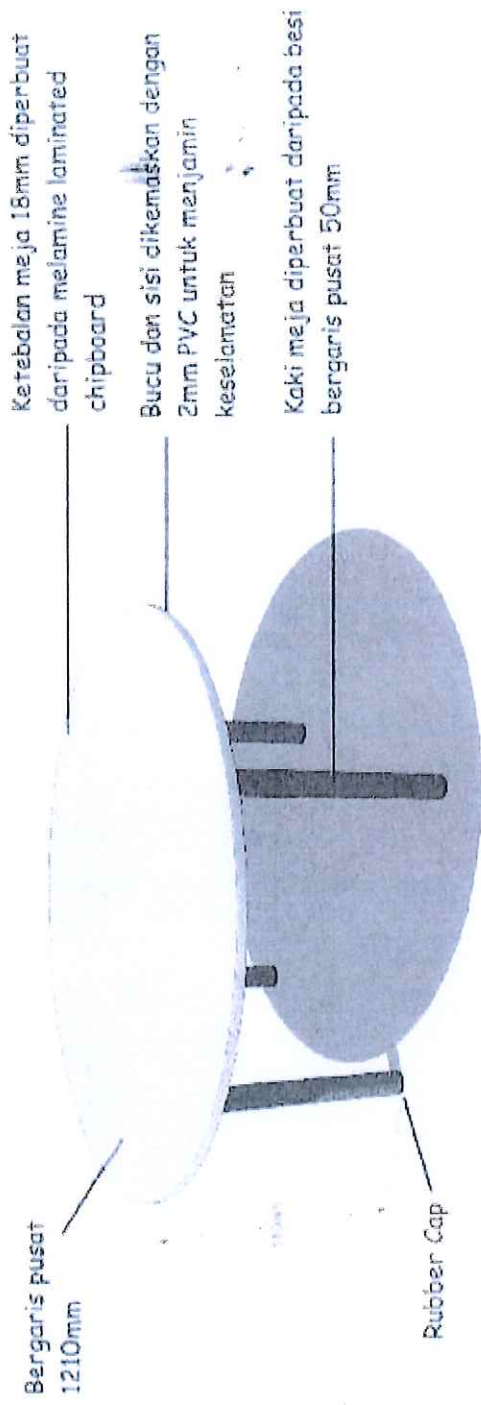

PANDANGAN ISOMETRIC

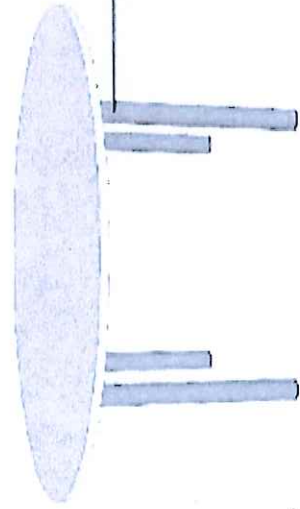

PANDANGAN SISI

Kaki meja diperbuat daripada besi bergaris pusat 50mm

Rangka meja diperbuat daripada besi segiempat 25mm

* semua bahagian besi dikemaskan dengan epoxy powder coat warna kelabu gelap

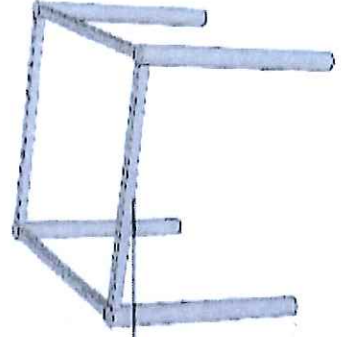

PANDANGAN TERCERAI

DIM	KATIL BESI (KELAMIN)
A	1920mm-1940mm
B	1519mm-1530mm
C	918mm-938mm
D	833mm-853mm
E	260mm-280mm
F	505mm-525mm

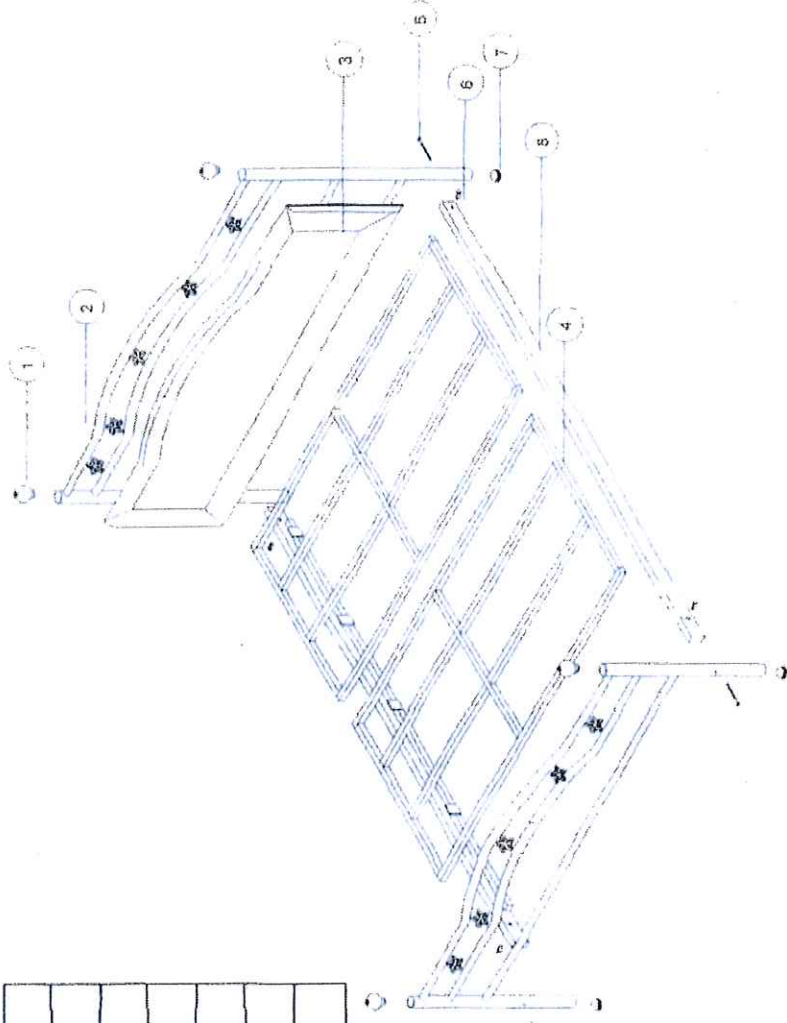

NO	ITEM	SPECIFICATION
1	ACCESSORIES	4 PCS.
2	HEAD BORD	ROUND TOBE WITH EPOXY FINISH
3	HEAD BORD	PLYWOOD COUY FOAM & FABRIC/PVC
4	BED BASE WITH PLYWOOD 6mm THK.	2 UNIT
5	ALLEN SCREW	4 PCS
6	ROUND NUT	4 PCS
7	RUBBER STUD	4 PCS
8	BED BASE	1 UNIT.

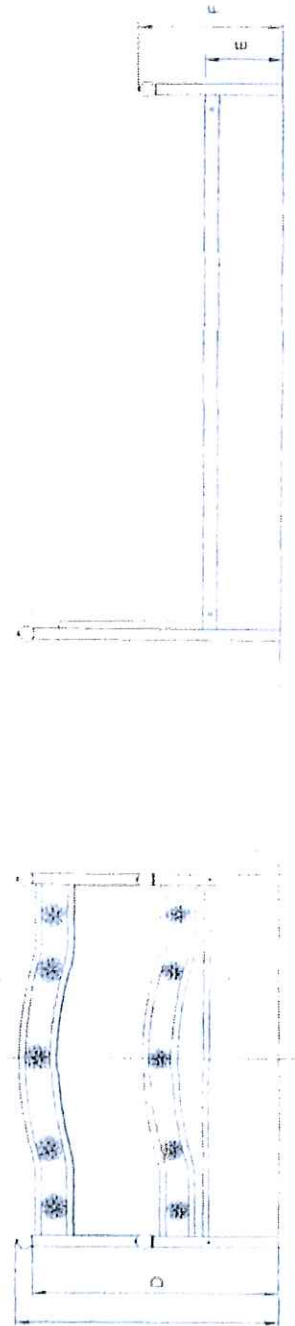

Item 57 :
Katil Besi (Kelamin)

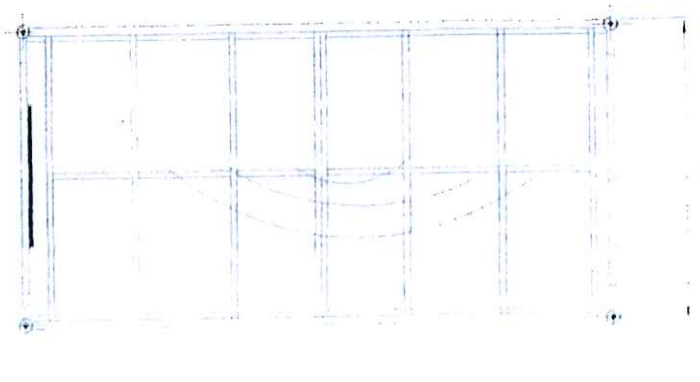

DIM	KATIL BESI (BUJANG)
A	1920mm-1940mm
B	960mm-980mm
C	916mm-938mm
D	833mm-853mm
E	260mm-280mm
F	505mm-525mm

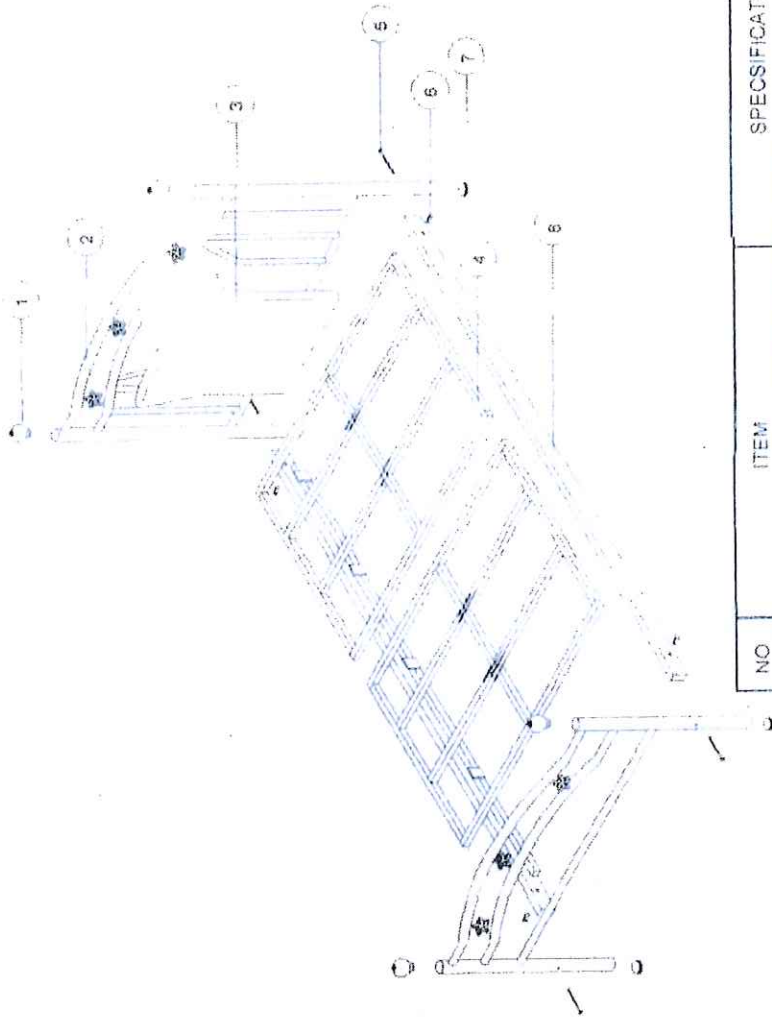

NO	ITEM	SPECIFICATION
1	ACCESSORIES	4 PCS
2	HEAD BORD	ROUND TOBE WITH EPOXY FINISH
3	HEAD BORD	PLYWOOD COW FOAM & FABRIC/PVC
4	BED BASE WITH PLYWOOD 6mm THK	2 UNIT
5	ALLEN SCREW	4 PCS
6	ROUND NUT	4 PCS
7	RUBBER STUD	4 PCS
8	BED BASE	1 UNIT

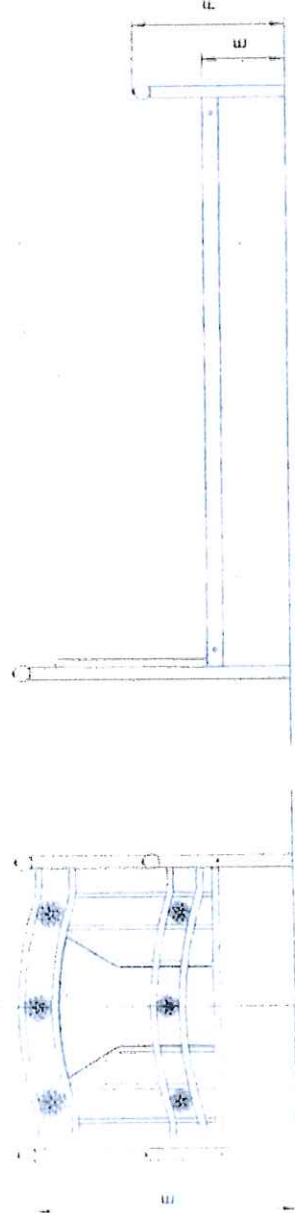

Item 58 :
Katil BESI (Bujang)